

Valera[®]
HOSPITALITY







 **Hairdryers for Heavy Duty Use**

P. 12

Hairdryers for public areas with high frequency of users
Haartrockner für öffentliche Anlagen mit hoher Nutzungsfrequenz
Asciugacapelli per impianti pubblici con alta frequenza di utenti
Sèche-cheveux pour structures publiques avec grande fréquence d'utilisation

 **Hairdryers for Medium Duty Use**

P. 14

Hairdryers for small public places with low frequency of users and for hotel rooms
Haartrockner für kleinere öffentliche Einrichtungen mit niedriger Nutzungsfrequenz und für Gästezimmer
Asciugacapelli per piccoli impianti pubblici con bassa frequenza di utenti e per camere d'albergo
Sèche-cheveux pour petites installations publiques avec basse fréquence d'utilisation et pour chambres d'hôtels

 **Hairdryers for Hotel Rooms**

P. 20

Hairdryers for hotel rooms
Haartrockner für Gästezimmer
Asciugacapelli per camere d'albergo
Sèche-cheveux pour chambres d'hôtels

 **Automatic Hand Dryer**

P. 48

Automatic hand dryer
Automatischer Händetrockner
Asciugamani automatico
Sèche-mains automatique mural

 **Magnifying Mirrors**

P. 49

Magnifying mirrors
Vergrößerungsspiegel
Specchi ingranditori
Miroirs agrandisseurs

Our commitment for sustainability



In-House production

Development, design and manufacturing in Ligornetto/Switzerland

Eigene Produktion

Entwicklung, Design und Fertigung in Ligornetto/Schweiz

Produzione interna

Sviluppo, progettazione e produzione a Ligornetto/Svizzera

Production interne

Développement, conception et fabrication à Ligornetto/Suisse



Clean energy

Factory powered by electricity from renewable sources

Saubere Energie

Strom aus erneuerbaren Quellen für die Produktion

Energia pulita

Fabbrica alimentata con energia elettrica da fonti rinnovabili

Énergie propre

Notre usine emploie de l'électricité provenant de sources renouvelables



Long-life products

Designed to last, with best quality components

Langlebige Produkte

Langlebiges Design mit Komponenten bester Qualität

Prodotti di lunga durata

Progettati per durare, con componenti di alta qualità

Produits longue durée

Conçus pour durer, comprenant des composants de la meilleure qualité



Low consumption

Excellent drying rates even at low wattages

Niedriger Verbrauch

Hervorragende Trocknungsraten auch bei niedriger Wattzahl

Bassi consumi

Eccellenti parametri di asciugatura anche a potenza ridotta

Basse consommation

Taux de séchage excellent même à faible puissance



Recyclable materials

Valera is a member of the Swiss Recycling Society S.EN.S.*

Wiederverwertbare Materialien

Valera ist Mitglied der Schweizer Recycling-Gesellschaft S.EN.S.*

Materiali riciclabili

Valera è membro della Fondazione Svizzera per il Riciclo S.EN.S.*

Matériaux recyclables

Valera est membre de la Fondation suisse S.EN.S.*



Social Compliance

Certified quality of working conditions

Social Compliance

Zertifizierte Qualität der Arbeitsbedingungen

Responsabilità Sociale

Qualità certificata delle condizioni di lavoro

Responsabilité sociale

Qualité des conditions de travail certifiée

Stiftung Entsorgung Schweiz: Swiss Society for the Recycling of electrical and electronic appliances. Schweizer Gesellschaft für das Recycling elektrischer und elektronischer Geräte. Società Svizzera per il riciclaggio di apparecchi elettrici ed elettronici. Société suisse de recyclage des appareils électriques et électroniques.



Swiss Quality for hotels of the future

Valera Hospitality, number one in hotel hairdryers, focuses on environmentally friendly concepts. With durable appliances and energy-saving functions, safety and hygiene, sustainability becomes concrete. In a timeless, elegant design and with space-saving, black, white and chrome versions, no wish is left unfulfilled in any ambience.

Schweizer Qualität für die Hotels der Zukunft

Valera Hospitality, Nummer Eins in Hotelhaartrocknern, setzt auf umweltfreundliche Konzepte. Mit langlebigen Geräten und energiesparenden Funktionen, Sicherheit und Hygiene wird Nachhaltigkeit konkret. In zeitlos elegantem Design und mit platzsparenden, schwarzen, weißen und verchromten Ausführungen bleiben in keinem Ambiente Wünsche offen.

Qualità svizzera per gli hotel del futuro

Valera Hospitality, numero uno nel settore degli asciugacapelli per hotel, si impegna su concept ecosostenibili. Con apparecchi resistenti nel tempo e funzioni di risparmio energetico, sicurezza e igiene, la sostenibilità si fa concreta. Grazie a un design elegante e senza tempo e alle versioni salvaspazio, nere, bianche e cromate, nessun desiderio rimane insoddisfatto, in qualsiasi contesto.

La Qualité Suisse pour les hôtels du futur

Valera Hospitality, numéro un des sèche-cheveux pour hôtels, tient à développer des produits respectueux de l'environnement. Nos appareils longue durée, économes en énergie, sûrs et hygiéniques sont l'expression concrète de notre engagement pour la durabilité. Grâce à leur forme intemporelle et élégante, en versions compactes, noires, blanches ou chromées, nos produits s'adaptent parfaitement à tous les environnements.

SWISSMADE 



Valera Swiss Production

In-house in good hands

EN | Reliable quality from the design to final inspection

Valera looks back on almost 70 years of experience in the production of haircare appliances. Our products are based on in-house research & development. Valera designs, develops and produces all hair and hand dryers in its own factory in Ligornetto in the Swiss canton of Ticino. The concept of "total quality" is constantly and uncompromisingly applied to all business sectors. Valera has been certified ISO 9001 since 1995.

DE | Zuverlässige Qualität vom Entwurf bis zur Endkontrolle

Valera blickt auf eine fast 70-jährige Erfahrung in der Herstellung von Haarpflegegeräten zurück. Unsere Produkte basieren auf eigener Forschung und Entwicklung. Valera designt, entwickelt und produziert alle Haar- und Händetrockner im eigenen Werk in Ligornetto im Schweizer Kanton Tessin. Das Konzept „Total Quality“ findet in allen Betriebszweigen ständige und kompromisslose Anwendung. Valera erhielt bereits 1995 die Zertifizierung nach ISO 9001.

IT | Qualità affidabile dalla progettazione al controllo finale

Valera vanta quasi 70 anni di esperienza nella produzione di apparecchi per la cura dei capelli. I nostri prodotti si basano su ricerca e sviluppo interni. Progettiamo, sviluppiamo e produciamo tutti gli asciugacapelli e gli asciugamani nel nostro stabilimento di Ligornetto, nel cantone svizzero del Ticino. Appliciamo il concetto di "qualità totale" a tutti i settori aziendali, costantemente e senza compromessi. Valera è certificata ISO 9001 dal 1995.

FR | Qualité fiable, de la conception à l'inspection finale

Valera s'appuie sur presque 70 ans d'expérience dans la production d'appareils de coiffure entièrement conçus par son département de recherche et développement interne. Valera conçoit, développe et produit tous ses sèche-cheveux et sèche-mains dans son usine de Ligornetto, dans le canton suisse du Tessin. Le concept de « qualité totale » est appliqué de manière constante et sans compromis à tous les secteurs de l'entreprise. Valera est certifiée ISO 9001 depuis 1995.

Precision in every step

Guaranteeing the proven Swiss Quality by Valera, means taking care of every little step in the assembling process of our appliances. Utmost attention to details is the key for creating an excellent final product. Therefore we believe in experience, in precision, in dedication. We rely on our people. Swiss Quality is made with passion.

Präzision in jedem Schritt

Die bewährte Schweizer Qualität von Valera zu garantieren, bedeutet, dass wir uns um jeden kleinen Schritt im Montageprozess unserer Geräte kümmern. Höchste Aufmerksamkeit für Details ist der Schlüssel für ein hervorragendes Endprodukt. Deshalb setzen wir auf Erfahrung, auf Präzision, auf Hingabe. Wir zählen auf unsere Mitarbeiter. Schweizer Qualität wird mit Leidenschaft gemacht.

Precisione in ogni fase

Garantire la proverbiale Qualità Svizzera di Valera significa curare ogni piccolo passaggio nel processo di assemblaggio dei nostri apparecchi. La massima attenzione ai dettagli è la chiave per creare un prodotto finale eccellente: per questo crediamo nell'esperienza, nella precisione, nell'impegno. Ci affidiamo ai nostri collaboratori. La Qualità Svizzera è fatta con passione.

Précision à chaque étape

Valera s'attache à garantir la Qualité Suisse éprouvée à chaque étape du processus d'assemblage de ses appareils. L'attention extrême aux détails est fondamentale pour obtenir un produit final d'excellence. Pour ça nous croyons à l'expérience, à la précision, au dévouement. Nous comptons sur nos collaborateurs. La Qualité Suisse est faite avec passion.



SWISSMADE 

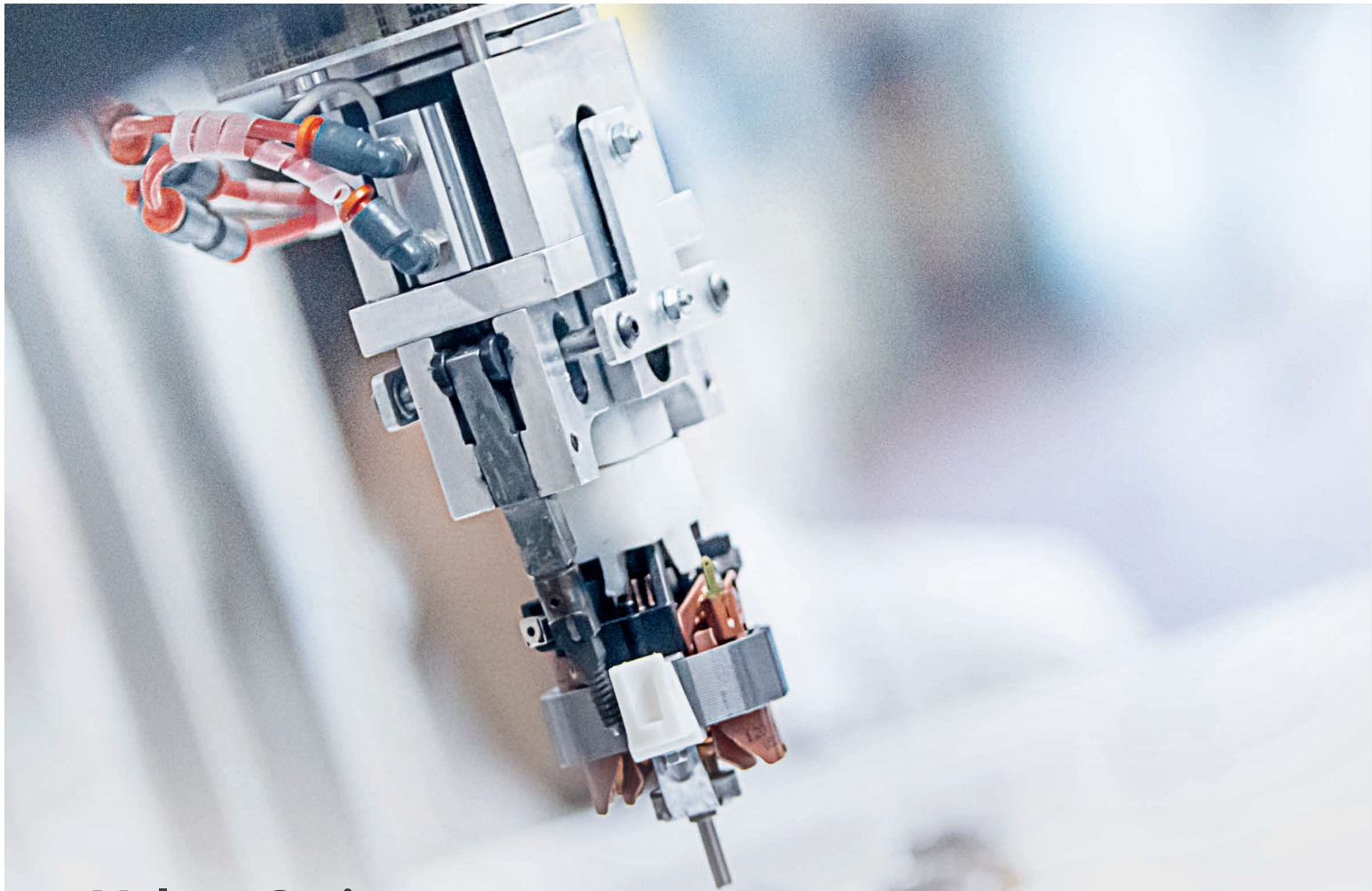

Valera Swiss Technology

Excellent quality for safety,
high performance and long life

EN | We apply selected technical components to build long-life products for frequent use, meeting the highest demands of top-class hotels and environmentally conscious clients as well as the strictest safety standards. All Valera appliances carry the test symbols of internationally renowned institutes.

DE | Wir verwenden ausgewählte technische Komponenten mit dem Ziel, langlebige Produkte für den häufigen Gebrauch zu fertigen, die den höchsten Ansprüchen der Spitzenhotellerie und umweltbewusster Kunden sowie den strengsten Sicherheitsstandards gerecht werden. Alle Valera Geräte tragen die Prüfzeichen von international anerkannten Instituten.

IT | Utilizziamo componenti tecnici selezionati per costruire prodotti di lunga durata per un uso frequente, che soddisfino le più alte esigenze degli hotel di fascia alta e dei clienti consapevoli delle tematiche ambientali, nonché i più severi standard di sicurezza. Tutti gli apparecchi Valera riportano i simboli di certificazione di istituti di fama internazionale.

FR | Nous employons des composants techniques soigneusement sélectionnés, pour fabriquer des produits longue durée destinés à un usage fréquent et qui répondent aux exigences les plus strictes des hôtels de prestige et des clients soucieux de l'environnement, tout en respectant les normes de sécurité les plus rigoureuses. Tous les appareils Valera portent la marque de contrôle d'organismes internationaux reconnus.

BRUSH-LESS
ENDURO
 BLDC MOTOR
10000 h
 HEAVY DUTY



ENDURO Brushless Digital BLDC Motor

EN | BLDC motors guarantee a service life of up to 10,000 hours (5 times longer than AC motors), a lighter weight and the prevention of environmental pollution through carbon dust emission.

DE | BLDC-Motoren garantieren eine Betriebszeit von bis zu 10.000 Stunden (5-mal länger als AC-Motoren), haben ein geringes Gewicht und belasten die Umwelt nicht mit Kohlenstaub-Emissionen.

IT | I motori BLDC garantiscono una durata fino a 10.000 ore (5 volte in più rispetto ai motori AC), hanno un peso ridotto e non inquinano l'ambiente con emissioni di polvere di carbone.

FR | Les moteurs BLDC ont une durée de vie jusqu'à 10 000 heures (5 fois plus que les moteurs AC), un poids plus léger et ne polluent pas l'environnement avec des émissions de poussière de charbon.

LONG-LIFE AC Universal Motor



EN | AC (Alternated Current) motors are typically used in real professional hairdryers. They produce a high air flow and pressure and have an expected average life of approx. 2000 hours.

DE | AC-Kollektormotoren kommen in professionellen Haartrocknern zum Einsatz. Sie produzieren einen hohen Luftstrom und -druck und haben eine Lebensdauer von etwa 2000 Stunden.

IT | I motori AC (Corrente Alternata) sono i motori degli asciugacapelli professionali. Essi producono una grande portata e pressione dell'aria e hanno una durata media di circa 2000 ore.

FR | Les moteurs AC (Courant Alternatif) sont utilisés dans les sèche-cheveux professionnels. Ils procurent un puissant flux et pression de l'air et ont une durée de vie d'environ 2000 heures.



LONG-LIFE DC-PRO Motor

EN | Ultralight DC-PRO motors produce a very high air flow and pressure, very similar to the classic but heavier AC motors. The expected average life of this motor is approx. 1200 hours.

DE | Die ultraleichten DC-PRO-Motoren produzieren einen sehr hohen Luftstrom und -druck ähnlich dem der klassischen, aber schwereren AC-Motoren. Ihre Lebensdauer beträgt etwa 1200 Stunden.

IT | I motori ultraleggeri DC-PRO assicurano una elevata portata e pressione dell'aria molto simile a quella prodotta dai più pesanti classici motori AC. Durata media del motore: 1200 ore.

FR | Les moteurs ultra légers DC-PRO assurent un flux et pression de l'air similaire à celles des moteurs AC traditionnels. Durée moyenne du moteur : 1200 heures.



COMPACT DC Motor

EN | DC motors are "direct current" motors. Their ultralight weight and particularly small dimension allow very compact designs of hairdryers. The expected average life of this motor is approx. 800 h.

DE | DC-Motoren sind Gleichstrom-Motoren. Ihr ultraleichtes Gewicht und besonders kleine Abmessungen ermöglichen sehr kompakte Haartrockner-Designs. Durchschnittliche Lebensdauer: etwa 800 Stunden.

IT | I motori DC sono motori in corrente continua. La loro leggerezza e le dimensioni ridotte consentono un design di asciugacapelli molto compatti. Durata media del motore: 800 ore.

FR | Les moteurs DC sont des moteurs à "courant continu". Leur poids ultraléger et leur petite taille permettent des designs très compacts de sèche-cheveux. La durée de vie moyenne prévue de ce moteur est d'env. 800 h.

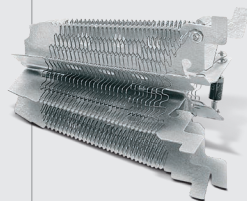

Ripple wire SECURITY heating element

EN | VALERA uses exclusively SECURITY ripple wire heating elements. The shape of the electric filament is directly formed on the mica card bearing. The assembling process is fully automatic in order to ensure an excellent stability. This superior type of heating element allows higher quality and safety, more constant distribution of the temperature of the air flow and ensures a longer life if compared with common spiral wire heating elements.

DE | VALERA verwendet ausschließlich SECURITY Welldrahtheizelemente. Der Heizdraht ist nicht spiralförmig, sondern wellenförmig geformt. Die gesamte Heizdrahtverarbeitung erfolgt vollkommen automatisch direkt auf dem Mikanit-Träger. Dadurch wird höchste Präzision garantiert, was wiederum eine gleichmäßige Verteilung der Temperatur und eine längere Lebensdauer des Heizelementes bedeutet. Höchste Qualität, höchste Sicherheit.

IT | VALERA utilizza esclusivamente resistenze a onda SECURITY. Queste sono riconoscibili dalla caratteristica ondulazione del filamento resistivo. Le resistenze ad onda sono prodotte in automatico, hanno una grande stabilità e garantiscono un migliore controllo della temperatura e dei dispositivi di sicurezza installati oltre che una maggiore durata nel tempo. Massima qualità, massima sicurezza.

FR | VALERA utilise exclusivement des résistances aux ondes SECURITY. Elles sont facilement reconnaissables à leur filament de résistance ondulé. Les résistances aux ondes sont produites automatiquement. Elles sont très stables, garantissent un meilleur contrôle de la température et des dispositifs de sécurité installés et ont une durée de vie maximale. La qualité et la sécurité au top.



ElectroStop for highest protection

EN | The ElectroStop residual current device (RCD) in the wall holder minimizes the risk of electrocution from electric shocks caused by any potential leakage current (e.g. the hairdryer accidentally coming into contact with water). ElectroStop is essential in rooms with no residual current device. Moreover, thanks to its rated differential current ≤ 10 mA, ElectroStop is much more sensitive and effective than the commonly installed devices rated ≤ 30 mA.

DE | Der Fehlerstrom-Schutzschalter ElectroStop im Wandhalter minimiert das Risiko eines gesundheitsgefährdenden Stromschlags aufgrund eines Fehlerstroms (z.B. bei versehentlichem Kontakt des Haartrockners mit Wasser). ElectroStop ist fundamental in Räumen ohne Fehlerstrom-Schutzschalter. Darüber hinaus ist ElectroStop dank seines Bemessungsdifferenzstroms ≤ 10 mA wesentlich sensibler und effektiver als die üblicherweise installierten Fehlerstrom-Schutzschalter mit ≤ 30 mA.

IT | L'interruttore differenziale ElectroStop presente nel supporto dell'asciugacapelli riduce al minimo il rischio di folgorazione da scossa elettrica per una eventuale corrente di dispersione (p.es. per contatto accidentale dell'asciugacapelli con acqua). ElectroStop è essenziale in ambienti sprovvisti di interruttore differenziale. Inoltre, grazie alla sua corrente differenziale nominale ≤ 10 mA, ElectroStop è molto più sensibile ed efficace rispetto ai dispositivi comunemente installati con una corrente differenziale nominale ≤ 30 mA.

FR | L'interrupteur différentiel ElectroStop dans le support du sèche-cheveux minimise le risque d'électrocution dû au courant de fuite éventuel (par ex. par contact accidentel du sèche-cheveux avec de l'eau). ElectroStop est essentiel dans les environnements sans interrupteur différentiel. De plus, grâce à son courant différentiel nominal ≤ 10 mA, ElectroStop est beaucoup plus sensible que le courant ≤ 30 mA des interrupteurs différentiels couramment installés.

Valera

Security Concepts

Watch out for these icons



EN | Hairdryers equipped with

01. Auto-reset switch-off thermostat to prevent overheating
02. Security on/off "Push" button to prevent unguarded operation
03. Automatic on/off safety switch to stop operation when hairdryer is inserted in the wall holder
04. Residual current device in the wall holder (RCD)

DE | Haartrockner verfügen über

01. Thermoschalter mit automatischer Rückschaltung zum Schutz vor Überhitzung
02. Ein/Aus-Druckschalter zur Vermeidung unbewachten Betriebs
03. Ein/Aus-Sicherheitsautomatik zum Abschalten, wenn der Haartrockner in den Wandhalter eingesetzt wird
04. Fehlerstrom-Schutzschalter im Wandhalter

IT | Asciugacapelli dotati di

01. Termostato a riarmo automatico per evitare surriscaldamenti
02. Pulsante acceso/spento per prevenire il funzionamento incustodito
03. Interruttore automatico di sicurezza on/off per interrompere il funzionamento quando l'asciugacapelli è inserito nel supporto
04. Interruttore differenziale nel supporto

FR | Sèche-cheveux avec

01. Thermostat à réarmement automatique pour éviter les surchauffes
02. Bouton poussoir on/off pour éviter le fonctionnement sans surveillance
03. Interrupteur de sécurité automatique on/off pour arrêter le fonctionnement lorsque le sèche-cheveux est inséré dans le support
04. Interrupteur différentiel dans le support



01. Auto-reset switch-off thermostat to prevent overheating
02. Security on/off "Push" button to prevent unguarded operation
03. Safety on/off switch of the wall holder to stop operation

01. Thermoschalter mit automatischer Rückschaltung zum Schutz vor Überhitzung
02. Ein/Aus-Druckschalter zur Vermeidung unbewachten Betriebs
03. Ein/Aus Sicherheitsschalter im Wandhalter zum Abschalten

01. Termostato a riarmo automatico per evitare surriscaldamenti
02. Pulsante acceso/spento per prevenire il funzionamento incustodito
03. Interruttore acceso/spento nel supporto per spegnere l'apparecchio

01. Thermostat à réarmement automatique pour éviter les surchauffes
02. Bouton poussoir on/off pour éviter le fonctionnement sans surveillance
03. Interrupteur de sécurité on/off dans le support pour éteindre



01. Auto-reset switch-off thermostat to prevent overheating
02. Security thermal cutoff in case of accidental overheating

01. Thermoschalter mit automatischer Rückschaltung zum Schutz vor Überhitzung
02. Thermosicherung im Falle versehentlichen Überhitzens

01. Termostato a riarmo automatico per evitare surriscaldamenti
02. Termofusibile di sicurezza in caso di surriscaldamento accidentale

01. Thermostat à réarmement automatique pour éviter les surchauffes
02. Fusible thermique de sécurité en cas de surchauffe accidentelle



01. Auto-reset switch-off thermostat to prevent overheating
02. Security on/off "Push" button to prevent unguarded operation

01. Thermoschalter mit automatischer Rückschaltung zum Schutz vor Überhitzung
02. Ein/Aus-Druckschalter zur Vermeidung unbewachten Betriebs

01. Termostato a riarmo automatico per evitare surriscaldamenti
02. Pulsante acceso/spento per prevenire il funzionamento incustodito

01. Thermostat à réarmement automatique pour éviter les surchauffes
02. Bouton poussoir on/off pour éviter le fonctionnement sans surveillance

Hairdryers for **Heavy** Duty Use

For public areas with **high frequency of users**,
such as swimming pools, gyms, wellness/fitness clubs, spas, etc.

Für öffentliche Anlagen mit **hoher Nutzungsfrequenz**,
wie Schwimm- und Sporthallen, Wellness- und Fitness-Clubs, Spas usw.

Per impianti pubblici con **alta frequenza di utenti**,
come piscine, palestre, wellness/fitness clubs, spa, ecc.

Pour structures publiques avec **grande fréquence d'utilisation**,
comme piscines, gymnases, clubs de wellness/fitness, spa, etc.

Hotello

Extremely durable
and ultra-powerful

MOD. 832.11/T

Hotello BLDC 1500W

EN | Wall-mounted hairdryer with hose

- Durable "Heavy Duty" ENDURO Brushless BLDC motor
- Super compact (147 x 238 mm)
- Powerful airflow thanks to a re-designed aeration module
- Automatic switching on when removing the handgrip from holder
- 8 mins automatic safety timer
- "Cool touch" swivel handgrip
- Extensible hose (up to m 1,20)
- Easy wall-mounting without opening
- 2 possibilities of electrical wiring: direct connection to electrical mains (hardware), connection with plug (softwire)
- Fixation screws and screw anchors included

DE | Wandhaartrockner mit Schlauch

- Langlebiger "Heavy Duty"- Motor ENDURO Brushless BLDC
- Super kompakt (147 x 238 mm)
- Kraftvoller Luftstrom dank neu konzipierter Lüftungsgruppe
- Automatische Einschaltung nach Handgriff-Abnahme
- 8 Min. Sicherheits-Zeitschalter
- Cool-touch-Handgriff drehbar
- Flexibler Schlauch 1,20 m
- Praktische Wandmontage ohne das Gerät öffnen zu müssen
- 2 Anschlussmöglichkeiten: elektrischer Festanschluss, direkter Steckeranschluss
- Einschl. Schrauben und Dübel zur Wandbefestigung

IT | Asciugacapelli murale a tubo

- Motore durevole "Heavy Duty" ENDURO Brushless BLDC
- Super compatto (147 x 238 mm)
- Potente flusso d'aria grazie al gruppo ventilazione di nuova concezione
- Accensione automatica a sganciamento bocchetta
- Timer di sicurezza 8 min.
- Bocchetta cool-touch girevole
- Tubo flessibile estensibile fino a m 1,20
- Pratico montaggio a muro senza necessità di aprire l'apparecchio
- 2 possibilità di allacciamento a rete: diretto a cavo di rete che esce dal muro, alla presa tramite cavo con spina
- Completo di tasselli + viti per il fissaggio a muro

FR | Sèche-cheveux à montage mural avec tuyau

- Moteur durable "heavy duty" ENDURO Brushless BLDC
- Super compact (147 x 238 mm)
- Flux d'air puissant grâce au groupe de ventilation de nouvelle conception
- Allumage automatique à la prise en main du flexible
- Temporisateur de sécurité 8 min
- Embout « cool touch » tournant
- Tuyau souple extensible jusqu'à 1,20 m
- Montage au mur pratique sans ouverture de l'appareil
- 2 possibilités de raccordement au réseau électrique: raccord direct par câble d'alimentation à boîtier mural, raccord par câble avec fiche à prise électrique
- Jeu complet de chevilles + vis pour fixation au mur

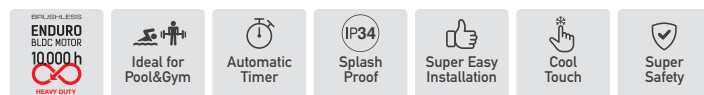

Colour: WHITE	<input type="radio"/>	Mod. 832.11/T
Colour: BLACK	<input checked="" type="radio"/>	Mod. 832.11/T MATT-BLACK

Hairdryers for **Medium** Duty Use

For small public places with **low frequency of users**,
such as swimming pools, gyms, wellness/fitness clubs, spas, etc.

Für kleinere öffentliche Einrichtungen mit **niedriger Nutzungsfrequenz**,
wie Schwimm- und Sporthallen, Wellness- und Fitness-Clubs, Spas usw.

Per piccoli impianti pubblici con **bassa frequenza di utenti**,
come piscine, palestre, wellness/fitness clubs, spa, ecc.

Pour petites installations publiques avec **basse fréquence d'utilisation**,
comme piscines, gymnases, clubs de wellness/fitness, spa, etc.

MOD. 832.02/T

Medium Duty Use 

Hotello Super AC 1400W

EN | Wall-mounted hairdryer with hose

- EXTRA LONG-LIFE AC Universal Motor
- Super compact (147 x 238 mm)
- Automatic switching on when removing the handgrip from holder
- 8 mins automatic safety timer
- "Cool touch" swivel handgrip
- Extensible hose (up to m 1,20)
- Easy wall-mounting without opening
- 2 possibilities of electrical wiring: direct connection to electrical mains (hardwire), connection with plug (softwire)
- Fixation screws and screw anchors included

DE | Wandhaartrockner mit Schlauch

- AC-Kollektormotor EXTRA LONG-LIFE
- Super kompakt (147 x 238 mm)
- Automatische Einschaltung nach Handgriff-Abnahme
- 8 Min. Sicherheits-Zeitschalter
- Cool-touch-Handgriff drehbar
- Flexibler Schlauch 1,20 m
- Praktische Wandmontage ohne das Gerät öffnen zu müssen
- 2 Anschlussmöglichkeiten: elektrischer Festanschluss, direkter Steckeranschluss
- Einschl. Schrauben und Dübel zur Wandbefestigung

IT | Asciugacapelli murale a tubo

- Motore a collettore AC EXTRA LONG-LIFE
- Super compatto (147 x 238 mm)
- Accensione automatica a sganciamento bocchetta
- Timer di sicurezza 8 min
- Bocchetta cool-touch girevole
- Tubo flessibile estensibile fino a m 1,20
- Pratico montaggio a muro senza necessità di aprire l'apparecchio
- 2 possibilità di allacciamento a rete: diretto a cavo di rete che esce dal muro, alla presa tramite cavo con spina
- Completo di tasselli + viti per il fissaggio a muro

FR | Sèche-cheveux à montage mural avec tuyau

- Moteur à collecteur AC EXTRA LONG-LIFE
- Super compact (147 x 238 mm)
- Allumage automatique à la prise en main du flexible
- Temporisateur de sécurité 8 min
- Embout « cool touch » tournant
- Tuyau souple extensible jusqu'à 1,20 m
- Montage au mur pratique sans ouverture de l'appareil
- 2 possibilités de raccordement au réseau électrique: raccord direct par câble d'alimentation à boîtier mural, raccord par câble avec fiche à prise électrique
- Jeu complet de chevilles + vis pour fixation au mur

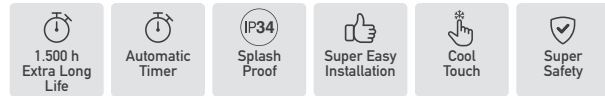

Colour: WHITE	<input type="radio"/>	Mod. 832.02/T
Colour: BLACK	<input checked="" type="radio"/>	Mod. 832.02/T MATT-BLACK



MOD. 832.02/RT

Hotello Super AC Shaver 1400W

EN | Same as mod. 832.02/T, with:

- Shaver socket 110-120V and 220-240V
- Safety isolating transformer

IT | Come mod. 832.02/T, con:

- Presa rasoio 110-120V e 220-240V
- Trasformatore d'isolamento di sicurezza

DE | Wie Mod. 832.02/T, mit:

- Rasiersteckdose 110-120V und 220-240V
- Sicherheits-Trenntransformator

FR | Comme mod. 832.02/T, avec:

- Prise rasoir 110-120V et 220-240V
- Transformateur de sécurité



Colour: WHITE	<input type="radio"/>	Mod. 832.02/RT
Colour: BLACK	<input checked="" type="radio"/>	Mod. 832.02/RT MATT-BLACK



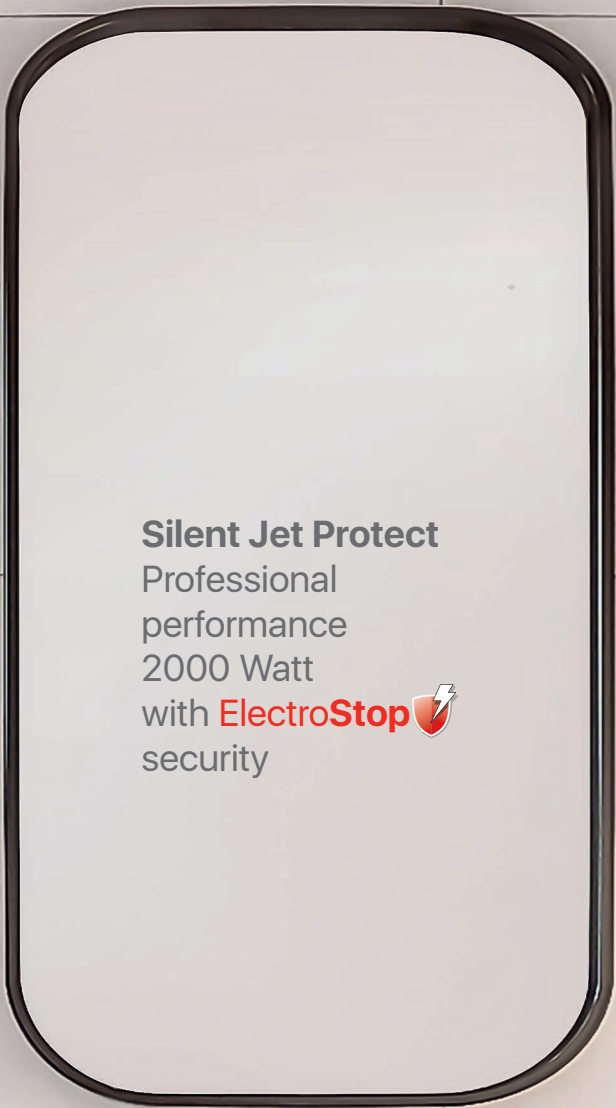

Silent Jet Protect
Professional
performance
2000 Watt
with **ElectroStop** 
security



MOD. 586.10/044.04

Medium Duty Use 

Silent Jet Protect 2000

2000W

EN | Hairdryer

- LONG-LIFE AC Universal Motor
- 6 air flow/temperature settings
- Removable metallic filter
- Concentrator nozzle
- On/Off push button

Wall holder

- ELECTROSTOP - Residual current device $\leq 10\text{mA}$
- Automatic On/Off safety switch

DE | Haartrockner

- Kollektormotor AC LONG-LIFE
- 6 Temperatur/Luftstrom-Schaltkombinationen
- Abnehmbarer Metallfilter
- Ondulierdüse
- Ein/Aus-Druckschalter

Wandhalter

- ELECTROSTOP - Fehlerstrom-Schutzschalter $\leq 10\text{mA}$
- Automatischer Ein/Aus-Sicherheitsschalter

IT | Asciugacapelli

- Motore a collettore AC LONG-LIFE
- 6 combinazioni di temperatura/flusso dell'aria
- Filtro metallico removibile
- Bocchetta
- Pulsante acceso/spento

Supporto da parete

- ELECTROSTOP - Interruttore differenziale $\leq 10\text{mA}$
- Interruttore automatico di sicurezza acceso/spento

FR | Sèche-cheveux

- Moteur à collecteur AC LONG-LIFE
- 6 combinaisons de température/ventilation
- Filtre métallique amovible
- Concentrateur d'air
- Bouton poussoir on/off

Support mural

- ELECTROSTOP - Interrupteur différentiel $\leq 10\text{mA}$
- Interrupteur de sécurité on/off automatique



Colour: WHITE



Mod. 586.10/044.04



MOD. 586.10/044.06

Silent Jet Protect 2000 Shaver

2000W

EN | Same as mod. 586.10/044.04 with:

- Shaver socket 110-120V and 220-240V
- Safety isolating transformer

DE | Wie Mod. 586.10/044.04, mit:

- Rasiersteckdose 110-120V und 220-240V
- Sicherheits-Trenntransformator

IT | Come mod. 586.10/044.04, con:

- Presa rasoio 110-120V e 220-240V
- Trasformatore d'isolamento di sicurezza

FR | Comme mod. 586.10/044.04, avec:

- Prise rasoir 110-120V et 220-240V
- Transformateur de sécurité



Colour: WHITE



Mod. 586.10/044.06





Swiss Metal Master
Very stylish,
very professional,
cool touch

MOD. 584.02/IP

Swiss Metal Master Push 2000W

EN | Professional steel hairdryer

- LONG-LIFE AC Universal Motor
- Metal body in chrome plated premium steel
- Ions generator
- 6 air flow/temperature combinations
- On/Off push button
- Ultra-narrow concentrator nozzle
- Removable metallic filter
- Spiral cable

DE | Professioneller Metall-Haartrockner

- LONG-LIFE AC Kollektormotor
- Metallgehäuse aus verchromtem Premium-Stahl
- Ionen-Generator
- 6 Temperatur/Luftstrom-Schaltkombinationen
- Ein/Aus-Druckschalter
- Extra schmale Ondulierdüse
- Abnehmbarer Metallfilter
- Spiralkabel

IT | Asciugacapelli professionale in metallo

- Motore a collettore AC LONG-LIFE
- Corpo in acciaio cromato Premium
- Generatore di ioni
- 6 combinazioni di temperatura/flusso dell'aria
- Pulsante acceso/spento
- Bocchetta ultrastretta
- Filtro metallico removibile
- Cordone spiralato

FR | Sèche-cheveux professionnel en métal

- Moteur à collecteur AC LONG-LIFE
- Corps en acier chromé Premium
- Ionisateur
- 6 combinaisons de température/ventilation
- Bouton poussoir on/off
- Embout concentrateur ultra-fin
- Filtre métallique amovible
- Cordon spiralé



Colour: CHROME



Mod. 584.02/IP

MOD. SXJ 8500 P

Medium Duty Use 

Swiss Silent Jet 8500 Push 2000W

EN | Ultra-silent professional hairdryer

- LONG-LIFE AC Universal Motor
- 6 air flow/temperature settings
- On/Off push button
- Removable metallic filter
- TOUCH ME cool nozzle (7,5 cm)
- Spiral cable

DE | Ultraleiser professioneller Haartrockner

- Kollektormotor AC LONG-LIFE
- 6 Temperatur/Luftstrom-Schaltkombinationen
- Ein/Aus-Druckschalter
- Abnehmbarer Metallfilter
- Kühle Düse TOUCH ME (7,5 cm)
- Spiralkabel

IT | Asciugacapelli professionale ultra silenzioso

- Motore a collettore AC LONG-LIFE
- 6 combinazioni di temperatura/flusso dell'aria
- Pulsante acceso/spento
- Filtro metallico removibile
- Bocchetta fredda TOUCH ME (7,5 cm)
- Cordone spiralato

FR | Sèche-cheveux professionnel ultra-silencieux

- Moteur à collecteur AC LONG-LIFE
- 6 combinaisons de température/ventilation
- Bouton poussoir on/off
- Filtre métallique amovible
- Embout froid TOUCH ME (7,5 cm)
- Cordon spiralé

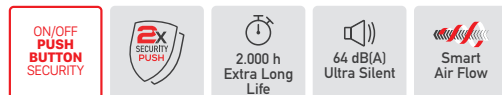

Colour: BLACK



Mod. SXJ 8500 P



MOD. SXJ 8500 RC TF

Swiss Silent Jet 8500 Ionic TF 2000W

EN | Ultra-silent professional hairdryer

- LONG-LIFE AC Universal Motor
- Security thermal cutoff
- Ions generator
- 6 air flow/temperature settings
- Removable metallic filter
- 2 professional nozzles: TOUCH ME and standard
- SuperFlex cable with ROTOCORD

DE | Ultraleiser professioneller Haartrockner

- Kollektormotor AC LONG-LIFE
- Thermosicherung
- Ionen-Generator
- 6 Temperatur/Luftstrom-Schaltkombinationen
- Abnehmbarer Metallfilter
- 2 professionelle Ondulierdüsen: TOUCH ME und Standard
- Super-Flex-Kabel mit ROTOCORD

IT | Asciugacapelli professionale ultra silenzioso

- Motore a collettore AC LONG-LIFE
- Termofusibile di sicurezza
- Generatore di Ioni
- 6 combinazioni di temperatura/flusso dell'aria
- Filtro metallico removibile
- 2 bocchette professionali: TOUCH ME e standard
- Cordone SuperFlex con ROTOCORD

FR | Sèche-cheveux professionnel ultra-silencieux

- Moteur à collecteur AC LONG-LIFE
- Fusible thermique de sécurité
- Ionisateur
- 6 combinaisons de température/ventilation
- Filtre métallique amovible
- 2 embouts professionnelles: TOUCH ME et standard
- Câble SuperFlex avec ROTOCORD

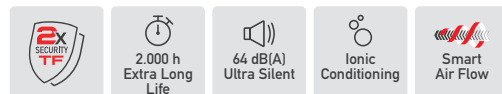

Colour: BLACK



Mod. SXJ 8500 RC TF





Hairdryers for **Hotel** Rooms

For **non-public areas**, such as hotel bedrooms/bathrooms, guest-houses, ship cabins and private homes.

Für **nichtöffentliche Bereiche** wie Gästezimmer oder -bäder von Hotels, Pensionen, Schiffskabinen sowie private Wohnungen.

Per **aree non pubbliche**, come camere/bagni privati di alberghi, pensioni, cabine di navi e abitazioni private.

Pour **zones non publiques**: chambres à coucher/salles de bains privées d'hôtels, pensions, cabines d'embarcations et habitations privées.



MOD. 832.01/T

Hotello 1200W

EN | Wall-mounted hairdryer with hose

- Super compact (147 x 238 mm)
- Automatic switching on when removing the handgrip from holder
- 8 mins automatic safety timer
- "Cool touch" swivel handgrip
- Extensible hose (up to m 1,20)
- Easy wall-mounting without opening
- 2 possibilities of electrical wiring: direct connection to electrical mains (hardwire), connection with plug (softwire).
- Fixation screws and screw anchors included

DE | Wandhaartrockner mit Schlauch

- Super kompakt (147 x 238 mm)
- Automatische Einschaltung nach Handgriff-Abnahme
- 8 Min. Sicherheits-Zeitschalter
- Cool-touch-Handgriff drehbar
- Flexibler Schlauch 1,20 m
- Praktische Wandmontage ohne das Gerät öffnen zu müssen
- 2 Anschlussmöglichkeiten: elektrischer Festanschluss, direkter Steckeranschluss
- Einschl. Schrauben und Dübel zur Wandbefestigung

IT | Asciugacapelli murale a tubo

- Super compatto (147 x 238 mm)
- Accensione automatica a sganciamento bocchetta
- Timer di sicurezza 8 min
- Bocchetta cool-touch girevole
- Tubo flessibile estensibile fino a m 1,20
- Pratico montaggio a muro senza necessità di aprire l'apparecchio
- 2 possibilità di allacciamento a rete: diretto a cavo di rete che esce dal muro, alla presa tramite cavo con spina
- Completo di tasselli + viti per il fissaggio a muro

FR | Sèche-cheveux à montage mural avec tuyau

- Super compact (147 x 238 mm)
- Allumage automatique à la prise en main du flexible
- Temporisateur de sécurité 8 min
- Embout « cool touch » tournant
- Tuyau souple extensible jusqu'à 1,20 m
- Montage au mur pratique sans ouverture de l'appareil
- 2 possibilités de raccordement au réseau électrique: raccord direct par câble d'alimentation à boîtier mural, raccord par câble avec fiche à prise électrique
- Jeu complet de chevilles + vis pour fixation au mur

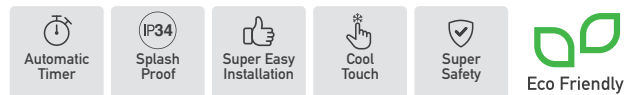

Colour: WHITE	<input type="radio"/>	Mod. 832.01/T
Colour: SILVER	<input type="radio"/>	Mod. 832.01/T SILVER
Colour: BLACK	<input type="radio"/>	Mod. 832.01/T MATT-BLACK



MOD. 832.01/RT

Hotello Shaver 1200W

EN | Same as mod. 832.01/T, with:

- Shaver socket 110-120V and 220-240V
- Safety isolating transformer

IT | Come mod. 832.01/T, con:

- Presa rasoio 110-120V e 220-240V
- Trasformatore d'isolamento di sicurezza

DE | Wie Mod. 832.01/T, mit:

- Rasiersteckdose 110-120V und 220-240 V
- Sicherheits-Trenntransformator

FR | Comme mod. 832.01/T, avec:

- Prise rasoir 110-120V et 220-240 V
- Transformateur de sécurité

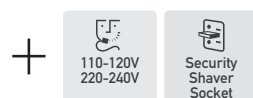

Colour: WHITE	<input type="radio"/>	Mod. 832.01/RT
Colour: BLACK	<input type="radio"/>	Mod. 832.01/RT MATT-BLACK



Silent Jet Protect
Professional
performance
and low consumption,
with **ElectroStop** 
security



MOD. 586.11/044.04

Silent Jet Protect 1200

1200W

EN | Hairdryer

- LONG-LIFE DC-Pro Motor
- 6 air flow/temperature settings
- Removable metallic filter
- Concentrator nozzle
- On/Off push button

Wall holder

- ELECTROSTOP - Residual current device $\leq 10\text{mA}$
- Automatic On/Off safety switch

DE | Haartrockner

- Motor DC-Pro LONG-LIFE
- 6 Temperatur/Luftstrom-Schaltkombinationen
- Abnehmbarer Metallfilter
- Onduliertdüse
- Ein/Aus-Druckschalter

Wandhalter

- ELECTROSTOP - Fehlerstrom-Schutzschalter $\leq 10\text{mA}$
- Automatischer Ein/Aus-Sicherheitsschalter

IT | Asciugacapelli

- Motore DC-Pro LONG-LIFE
- 6 combinazioni di temperatura/flusso dell'aria
- Filtro metallico removibile
- Bocchetta
- Pulsante acceso/spento

Supporto da parete

- ELECTROSTOP - Interruttore differenziale $\leq 10\text{mA}$
- Interruttore automatico di sicurezza acceso/spento

FR | Sèche-cheveux

- Moteur DC-Pro LONG-LIFE
- 6 combinaisons de température/ventilation
- Filtre métallique amovible
- Concentrateur d'air
- Bouton poussoir on/off

Support mural

- ELECTROSTOP - Interrupteur différentiel $\leq 10\text{mA}$
- Interrupteur de sécurité on/off automatique

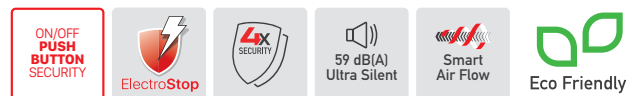

Colour: WHITE Mod. 586.11/044.04 WHITE



Mod. 586.11/044.06

Silent Jet Protect 1200 Shaver

1200W

EN | Same as mod. 586.11/044.04, with:

- Shaver socket 110-120V and 220-240V
- Safety isolating transformer

IT | Come mod. 586.11/044.04, con:

- Presa rasoio 110-120V e 220-240V
- Trasformatore d'isolamento di sicurezza

DE | Wie Mod. 586.11/044.04, mit:

- Rasiersteckdose 110-120V und 220-240V
- Sicherheits-Trenntransformator

FR | Comme mod. 586.11/044.04, avec:

- Prise rasoir 110-120V et 220-240V
- Transformateur de sécurité

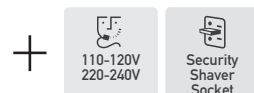

Colour: WHITE Mod. 586.11/044.06 WHITE



Excel Protect
Professional
excellence,
ultra-lightweight,
with **ElectroStop** 
security



MOD. 561.17/044.04

Excel Protect 1600

1600W

Hotel Rooms 

EN | Hairdryer

- Air flow control switch: 2 settings
- Air temperature control switch: 3 settings
- COOL air setting
- Removable filter
- On/Off push button

Wall holder

- ELECTROSTOP - Residual current device $\leq 10\text{mA}$
- Automatic On/Off safety switch

DE | Haartrockner

- Luftstrom-Einstellung: 2-stufige Schiebetaste
- Lufttemperatur-Einstellung: 3-stufige Schiebetaste
- Abkühlstufe COOL
- Abnehmbarer Filter
- Ein/Aus-Druckschalter

Wandhalter

- ELECTROSTOP - Fehlerstrom-Schutzschalter $\leq 10\text{mA}$
- Automatischer Ein/Aus-Sicherheitsschalter

IT | Asciugacapelli

- Tasto di regolazione del flusso d'aria: 2 posizioni
- Tasto di regolazione temperatura d'aria: 3 posizioni
- Posizione COOL per getto d'aria tiepida
- Filtro asportabile
- Pulsante acceso/spento

Supporto da parete

- ELECTROSTOP - Interruttore differenziale $\leq 10\text{mA}$
- Interruttore automatico di sicurezza acceso/spento

FR | Sèche-cheveux

- Commutateur de flux d'air: 2 positions
- Commutateur de chauffe: 3 positions
- Position COOL à air tiède
- Filtre amovible
- Bouton poussoir on/off

Support mural

- ELECTROSTOP - Interrupteur différentiel $\leq 10\text{mA}$
- Interrupteur de sécurité on/off automatique



Energy Saving

Colour: WHITE



Mod. 561.17/044.04 WHITE



MOD. 561.17/044.06

Excel Protect 1600 Shaver

1600W

EN | Same as mod. 561.17/044.04, with:

- Shaver socket 110-120V and 220-240V
- Safety isolating transformer

DE | Wie Mod. 561.17/044.04, mit:

- Rasiersteckdose 110-120V und 220-240V
- Sicherheits-Trenntransformator

IT | Come mod. 561.17/044.04, con:

- Presa rasoio 110-120V e 220-240V
- Trasformatore d'isolamento di sicurezza

FR | Comme mod. 561.17/044.04, avec:

- Prise rasoir 110-120V et 220-240V
- Transformateur de sécurité



Colour: WHITE



Mod. 561.17/044.06 WHITE



Excel
Professional drying,
ultra-lightweight,
with shaver socket





MOD. 561.17/044.05

Excel 1600 Shaver 1600W

EN | Hairdryer

- Air flow control switch:
2 settings
- Air temperature control switch:
3 settings
- COOL air setting
- Removable filter
- On/Off push button

Wall holder

- Shaver socket 110-120V and 220-240V
- Safety isolating transformer
- Automatic On/Off safety switch

DE | Haartrockner

- Luftstrom-Einstellung: 2-stufige Schiebetaste
- Lufttemperatur-Einstellung: 3-stufige Schiebetaste
- Abkühlstufe COOL
- Abnehmbarer Filter
- Ein/Aus-Druckschalter

Wandhalter

- Rasiersteckdose 110-120V und 220-240V
- Sicherheits-Trenntransformator
- Automatischer Ein/Aus-Sicherheitsschalter

IT | Asciugacapelli

- Tasto di regolazione del flusso d'aria: 2 posizioni
- Tasto di regolazione temperatura d'aria: 3 posizioni
- Posizione COOL per getto d'aria tiepida
- Filtro asportabile
- Pulsante acceso/spento

Supporto da parete

- Presa rasoio 110-120V e 220-240V
- Trasformatore d'isolamento di sicurezza
- Interruttore automatico di sicurezza acceso/spento



FR | Sèche-cheveux

- Commutateur de flux d'air: 2 positions
- Commutateur de chauffe: 3 positions
- Position COOL à air tiède
- Filtre amovible
- Bouton poussoir on/off

Support mural

- Prise rasoir 110-120V et 220-240V
- Transformateur de sécurité
- Interrupteur de sécurité on/off automatique



Colour: WHITE		561.17/044.05 WHITE
Colour: SILVER		561.17/044.05 SILVER
Colour: BLACK		561.17/044.05 BLACK



MOD. 542.06/044.04

Action Protect 1600

1600W

EN | Hairdryer

- Slide switch: 2 air flow settings, 3 air temperature settings
- COOL air setting
- On/Off push button
- Concentrator nozzle

Wall holder

- ELECTROSTOP - Residual current device $\leq 10\text{mA}$
- Automatic On/Off safety switch

DE | Haartrockner

- Schiebetaste: 2 Lüfterstufen, 3 Temperaturstufen
- Abkühlstufe COOL
- Ein/Aus-Druckschalter
- Ondulierdüse
- Welldrahtheizelement SECURITY

Wandhalter

- ELECTROSTOP - Fehlerstrom-Schutzschalter $\leq 10\text{mA}$
- Automatischer Ein/Aus-Sicherheitsschalter

IT | Asciugacapelli

- Tasto di regolazione: 2 posizioni di flusso d'aria, 3 posizioni di temperatura d'aria
- Posizione COOL per getto d'aria tiepida
- Pulsante acceso/spento
- Bocchetta

Supporto da parete

- ELECTROSTOP - Interruttore differenziale $\leq 10\text{mA}$
- Interruttore automatico di sicurezza acceso/spento

FR | Sèche-cheveux

- Interrupteur à glissière: 2 positions de ventilation, 3 positions de chauffe
- Position COOL à air tiède
- Bouton poussoir on/off
- Concentrateur d'air

Support mural

- ELECTROSTOP - Interrupteur différentiel $\leq 10\text{mA}$
- Interrupteur de sécurité on/off automatique



Energy Saving

Colour: WHITE/CHROME



Mod. 542.06/044.04 WHITE

Colour: BLACK/CHROME



Mod. 542.06/044.04 BLACK

MOD. 542.06/044.06

Action Protect 1600 Shaver

1600W

EN | Same as mod. 542.06/044.04, with:

- Shaver socket 110-120V and 220-240V
- Safety isolating transformer

IT | Come mod. 542.06/044.04, con:

- Presa rasoio 110-120V e 220-240V
- Trasformatore d'isolamento di sicurezza

DE | Wie Mod. 542.06/044.04, mit:

- Rasiersteckdose 110-120V und 220-240V
- Sicherheits-Trenntransformator

FR | Comme mod. 542.06/044.04, avec:

- Prise rasoir 110-120V et 220-240V
- Transformateur de sécurité

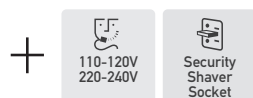

Colour: WHITE/CHROME  Mod. 542.06/044.06 WHITE

Colour: BLACK/CHROME  Mod. 542.06/044.06 BLACK



MOD. 542.06/044.03

Action Protect 1600 Socket

1600W

EN | Same as mod. 542.06/044.04, with:

- Standard European socket 16 A

IT | Come mod. 542.06/044.04, con:

- Presa standard europea 16A

DE | Wie Mod. 542.06/044.04, mit:

- Schuko-Steckdose 16A

FR | Comme mod. 542.06/044.04, avec:

- Prise européenne standard 16A



Colour: BLACK/CHROME  542.06/044.03 BLACK



Action Super Plus
Timeless elegance,
handy design



MOD. 542.06/044.05

Action Super Plus 1600 Shaver
1600W

EN | Hairdryer

- Slide switch:
2 air flow settings,
3 air temperature settings
- COOL air setting
- On/off push button
- Concentrator nozzle

Wall holder

- Shaver socket 110-120V and 220-240V
- Safety isolating transformer
- Automatic On/Off safety switch

DE | Haartrockner

- Schiebetaste:
2 Lüfterstufen,
3 Temperaturstufen
- Abkühlstufe COOL
- Ein/Aus-Druckschalter
- Ondulierdüse

Wandhalter

- Rasiersteckdose 110-120V
und 220-240V
- Sicherheits-Trenntransformator
- Automatischer Ein/Aus-
Sicherheitsschalter

IT | Asciugacapelli

- Tasto di regolazione:
2 posizioni di flusso d'aria,
3 posizioni di temperatura d'aria
- Posizione COOL per getto d'aria tiepida
- Pulsante acceso/spento
- Bocchetta

Supporto da parete

- Presa rasoio 110-120V e 220-240V
- Trasformatore d'isolamento di sicurezza
- Interruttore automatico di sicurezza
acceso/spento

FR | Sèche-cheveux

- Interrupteur à glissière:
2 positions de ventilation,
3 positions de chauffe
- Position COOL à air tiède
- Bouton poussoir on/off
- Concentrateur d'air

Support mural

- Prise rasoir 110-120V et 220-240V
- Transformateur de sécurité
- Interrupteur de sécurité on/off
automatique



Energy Saving

Colour: WHITE/CHROME	<input type="radio"/>	Mod. 542.06/044.05 WHITE
Colour: SILVER/CHROME	<input type="radio"/>	Mod. 542.06/044.05 SILVER
Colour: BLACK/CHROME	<input type="radio"/>	Mod. 542.06/044.05 BLACK

MOD. 542.14/038A

Action Super Plus 1800

1800W

EN | Hairdryer

- Slide switch: 2 air flow settings, 3 air temperature settings
- COOL air setting
- On/off push button
- Concentrator nozzle

Wall holder

- On/Off safety switch

DE | Haartrockner

- Schiebetaste: 2 Lüfterstufen, 3 Temperaturstufen
- Abkühlstufe COOL
- Ein/Aus-Druckschalter
- Onduliertdüse

Wandhalter

- Ein/Aus-Sicherheitsschalter

IT | Asciugacapelli

- Tasto di regolazione: 2 posizioni di flusso d'aria, 3 posizioni di temperatura d'aria
- Posizione COOL per getto d'aria tiepida
- Pulsante acceso/spento
- Bocchetta

Supporto da parete

- Interruttore acceso/spento di sicurezza



FR | Sèche-cheveux

- Interrupteur à glissière: 2 positions de ventilation, 3 positions de chauffe
- Position COOL à air tiède
- Bouton poussoir on/off
- Concentrateur d'air

Support mural

- Interrupteur de sécurité on/off



Colour: WHITE/CHROME		Mod. 542.14/038A WHITE
Colour: BLACK/CHROME		Mod. 542.14/038A BLACK
Colour: BLACK		Mod. 542.14/038A ALL BLACK



MOD. 542.06/038A

Action Super Plus 1600

1600W

EN | Same as mod. 542.14/038A, but: 1600W



IT | Come mod. 542.14/038A, ma: 1600W

DE | Wie Mod. 542.14/038A, jedoch: 1600W

FR | Comme mod. 542.14/038A, mais: 1600W



Energy Saving

Colour: WHITE/CHROME		Mod. 542.06/038A WHITE
Colour: BLACK/CHROME		Mod. 542.06/038A BLACK
Colour: BLACK		Mod. 542.06/038A ALL BLACK



MOD. 542.05/038A

Action Super Plus 1200

1200W

EN | Same as mod. 542.14/038A, but: 1200W



IT | Come mod. 542.14/038A, ma: 1200W

DE | Wie Mod. 542.14/038A, jedoch: 1200W

FR | Comme mod. 542.14/038A, mais: 1200W



Eco Friendly

Colour: WHITE/CHROME		Mod. 542.05/038A WHITE
Colour: BLACK/CHROME		Mod. 542.05/038A BLACK
Colour: BLACK		Mod. 542.05/038A ALL BLACK



Premium Protect
Classic design,
super lightweight,
with **ElectroStop** 
security



MOD. 533.03/044.04

Hotel Rooms 

Premium Protect 1200

1200W

EN | Hairdryer

- Slide switch: 2 air flow settings, 3 air temperature settings
- COOL air setting
- On/Off push button
- Concentrator nozzle

Wall holder

- ELECTROSTOP - RCD residual current device $\leq 10\text{mA}$
- Automatic On/Off safety switch

DE | Haartrockner

- Schiebetaste: 2 Lüfterstufen, 3 Temperaturstufen
- Abkühlstufe COOL
- Ein/Aus-Druckschalter
- Ondulierdüse

Wandhalter

- ELECTROSTOP - Fehlerstrom-Schutzschalter $\leq 10\text{mA}$
- Automatischer Ein/Aus-Sicherheitsschalter

IT | Asciugacapelli

- Tasto di regolazione: 2 posizioni di flusso d'aria, 3 posizioni di temperatura d'aria
- Posizione COOL per getto d'aria tiepida
- Pulsante acceso/spento
- Bocchetta

Supporto da parete

- ELECTROSTOP - Interruttore differenziale RCD $\leq 10\text{mA}$
- Interruttore automatico di sicurezza acceso/spento

FR | Sèche-cheveux

- Interrupteur à glissière: 2 positions de ventilation, 3 positions de chauffe
- Position COOL à air tiède
- Bouton poussoir on/off
- Concentrateur d'air

Support mural

- ELECTROSTOP - Interrupteur différentiel $\leq 10\text{mA}$
- Interrupteur de sécurité on/off automatique



Colour: WHITE



Mod. 533.03/044.04 WHITE

MOD. 533.03/044.06

Premium Protect 1200 Shaver

1200W

EN | Same as mod. 533.03/044.04, with:

- Shaver socket 110-120V and 220-240V
- Safety isolating transformer

DE | Wie Mod. 533.03/044.04, mit:

- Rasiersteckdose 110-120V und 220-240V
- Sicherheits-Trenntransformator

IT | Come mod. 533.03/044.04, con:

- Presa rasoio 110-120V e 220-240V
- Trasformatore d'isolamento di sicurezza

FR | Comme mod. 533.03/044.04, avec:

- Prise rasoir 110-120V et 220-240V
- Transformateur de sécurité



Colour: WHITE



Mod. 533.03/044.06 WHITE



Premium Smart
Classic design,
super lightweight,
with 16A Socket



MOD. 533.05/044.02

Premium Smart 1600 Socket
1600W

EN | Hairdryer

- Slide switch:
2 air flow settings,
3 air temperature settings
- COOL air setting
- On/Off push button
- Concentrator nozzle

Wall holder

- Standard European socket 16A

DE | Haartrockner

- Schiebetaste:
2 Lüfterstufen,
3 Temperurstufen
- Abkühlstufe COOL
- Ein/Aus-Druckschalter
- Ondulierdüse

Wandhalter

- Schuko-Steckdose 16A

IT | Asciugacapelli

- Tasto di regolazione:
2 posizioni di flusso d'aria,
3 posizioni di temperatura d'aria
- Posizione COOL per getto d'aria tiepida
- Pulsante acceso/spento
- Bocchetta

Supporto da parete

- Presa standard europea 16A

FR | Sèche-cheveux

- Interrupteur à glissière:
2 positions de ventilation,
3 positions de chauffe
- Position COOL à air tiède
- Bouton poussoir on/off
- Concentrateur d'air

Support mural

- Prise européenne standard 16A

MOD. 533.03/044.02

Premium Smart 1200 Socket
1200W

EN | Same as mod. 533.05/044.02, but:
1200W

DE | Wie Mod. 533.05/044.02, jedoch:
1200W

IT | Come mod. 533.05/044.02, ma:
1200W

FR | Comme mod. 533.05/044.02, mais:
1200W



Eco Friendly

Colour: WHITE



Mod. 533.03/044.02



Energy Saving

Colour: WHITE



Mod. 533.05/044.02

Premium Smart
Classic design,
super lightweight,
with Shaver Socket



MOD. 533.05/044.05

Premium Smart 1600 Shaver

1600W

EN | Hairdryer

- Slide switch: 2 air flow settings, 3 air temperature settings
- COOL air setting
- On/Off push button
- Concentrator nozzle

Wall holder

- On/Off safety switch
- Shaver socket 110-120V and 220-240V
- Safety isolating transformer

DE | Haartrockner

- Schiebetaste: 2 Lüfterstufen, 3 Temperaturstufen
- Abkühlstufe COOL
- Ein/Aus-Druckschalter
- Onduliertdüse

Wandhalter

- Ein/Aus-Sicherheitsschalter
- Rasiersteckdose 110-120V und 220-240V
- Sicherheits-Trenntransformator

IT | Asciugacapelli

- Tasto di regolazione: 2 posizioni di flusso d'aria, 3 posizioni di temperatura d'aria
- Posizione COOL per getto d'aria tiepida
- Pulsante acceso/spento
- Bocchetta

Supporto da parete

- Interruttore acceso/spento di sicurezza
- Presa rasoio 110-120V e 220-240V
- Trasformatore d'isolamento di sicurezza

FR | Sèche-cheveux

- Interrupteur à glissière: 2 positions de ventilation, 3 positions de chauffe
- Position COOL à air tiède
- Bouton poussoir on/off
- Concentrateur d'air

Support mural

- Interrupteur de sécurité on/off
- Prise rasoir 110-120V et 220-240V
- Transformateur de sécurité

MOD. 533.03/044.05

Premium Smart 1200 Shaver

1200W

EN | Same as mod. 533.05/044.05, but: 1200W

DE | Wie Mod. 533.05/044.05, jedoch: 1200W

IT | Come mod. 533.05/044.05, ma: 1200W

FR | Comme mod. 533.05/044.05, mais: 1200W



Eco Friendly

Colour: WHITE



Mod. 533.03/044.05



Colour: WHITE



Mod. 533.05/044.05

Premium Super
Very compact,
super lightweight,
individual settings



MOD. 533.05/038A

Premium 1600 Super
1600W

EN | Hairdryer

- Slide switch:
2 air flow settings,
3 air temperature settings
- COOL air setting
- On/Off push button
- Concentrator nozzle

Wall holder

- On/Off safety switch

DE | Haartrockner

- Schiebetaste:
2 Lüfterstufen,
3 Temperaturstufen
- Abkühlstufe COOL
- Ein/Aus-Druckschalter
- Ondulierdüse

Wandhalter

- Ein/Aus-Sicherheitsschalter

IT | Asciugacapelli

- Tasto di regolazione:
2 posizioni di flusso d'aria,
3 posizioni di temperatura d'aria
- Posizione COOL d'aria tiepida
- Pulsante acceso/spento
- Bocchetta

Supporto da parete

- Interruttore acceso/spento di sicurezza

FR | Sèche-cheveux

- Interrupteur à glissière:
2 positions de ventilation,
3 positions de chauffe
- Position COOL à air tiède
- Bouton poussoir on/off
- Concentrateur d'air

Support mural

- Interrupteur de sécurité on/off

MOD. 533.03/038A

Premium 1200 Super
1200W

EN | Same as mod. 533.05/038A, but:
1200W

DE | Wie Mod. 533.05/038A, jedoch:
1200W

IT | Come mod. 533.05/038A, ma:
1200W

FR | Comme mod. 533.05/038A, mais:
1200W



Eco Friendly

Colour: WHITE



Mod. 533.03/038A



Energy Saving

Colour: WHITE



Mod. 533.05/038A



Premium
Very compact,
super lightweight,
simple On/Off

MOD. 533.06/038A

Premium 1600
1600W

EN | Hairdryer

- On/Off push button
- 1 temperature/air flow setting
- Concentrator nozzle

Wall holder

On/Off safety switch

DE | Haartrockner

- Ein/Aus-Druckschalter
- 1 Temperatur-/Lüfterstufe
- Ondulierdüse

Wall holder

- Ein/Aus-Sicherheitsschalter

IT | Asciugacapelli

- Pulsante acceso/spento
- 1 posizione di temperatura/flusso d'aria
- Bocchetta

Wall holder

- Interruttore acceso/spento di sicurezza

FR | Sèche-cheveux

- Bouton poussoir on/off
- 1 position de température/flux d'air
- Concentrateur d'air

Wall holder

- Interrupteur de sécurité on/off

MOD. 533.04/038A

Premium 1200
1200W

EN | Same as mod. 533.06/038A, but:
1200W

DE | Wie Mod. 533.06/038A, jedoch:
1200W

IT | Come mod. 533.06/038A, ma:
1200W

FR | Comme mod. 533.06/038A, mais:
1200W

Colour: WHITE

Mod. 533.04/038A



MOD. 533.15/038B

Premium 1100
1100W

EN | Same as mod. 533.06/038A, but:
1100W

Wall holder

- Connection to electrical mains without switch

DE | Wie Mod. 533.06/038A, jedoch:
1100W

Wandhalter

- Netzanschluss ohne Schalter

IT | Come mod. 533.06/038A, ma:
1100W

Supporto

- Connessione alla rete elettrica senza interruttore

FR | Comme mod. 533.06/038A, mais:
1100W

Support mural

- Connexion à l'alimentation électrique sans interrupteur



Energy Saving

Colour: WHITE

Mod. 533.06/038A

Colour: WHITE

Mod. 533.15/038B



Executive
Simply elegant,
extremely compact

MOD. 554.02/038A

Executive 1200 Super 1200W

EN | Hairdryer

- Slide switch:
2 air flow/temperature settings
- On/Off push button
- Concentrator nozzle

Wall holder

- On/Off safety switch

DE | Haartrockner

- Schiebetaste:
2 Temperatur/Luftstrom-Schaltkombinationen
- Ein/Aus-Druckschalter
- Ondulierdüse

Wandhalter

- Ein/Aus-Sicherheitsschalter

IT | Asciugacapelli

- Tasto di regolazione:
2 combinazioni di temperatura/ flusso d'aria
- Pulsante acceso/spento
- Bocchetta

Supporto da parete

- Interruttore acceso/spento di sicurezza

FR | Sèche-cheveux

- Interrupteur à glissière:
2 combinaisons de température/ ventilation
- Bouton poussoir on/off
- Concentrateur d'air

Support mural

- Interrupteur de sécurité on/off

MOD. 554.01/038B

Executive 1200 1200W

EN | Hairdryer

- On/Off push button
- 1 temperature/air flow setting
- Concentrator nozzle

Wall holder

- Connection to electrical mains without switch

DE | Haartrockner

- Ein/Aus-Druckschalter
- 1 Temperatur-/Lüfterstufe
- Ondulierdüse

Wandhalter

- Netzanschluss ohne Schalter

IT | Asciugacapelli

- Pulsante acceso/spento
- 1 posizione di temperatura/flusso d'aria
- Bocchetta

Supporto da parete

- Connessione alla rete elettrica senza interruttore

FR | Sèche-cheveux

- Bouton poussoir on/off
- 1 positions de température/flux d'air
- Concentrateur d'air

Support mural

- Connexion à l'alimentation électrique sans interrupteur



Eco Friendly

Colour: WHITE



Mod. 554.02/038A



Eco Friendly

Colour: WHITE



Mod. 554.01/038B

Premium Drawer Hide-away and anti-dust solution

MOD. 533.05/033

Premium 1600 Drawer 1600W

EN | Hairdryer

- Slide switch:
2 air flow settings,
3 air temperature settings
- COOL air setting
- On/off push button
- Concentrator nozzle

Drawer holder

- On/off safety switch with pilot lamp
- Cable 3 m for connection to electrical mains

DE | Haartrockner

- Schiebetaste:
2 Lüfterstufen,
3 Temperaturstufen
- Abkühlstufe COOL
- Ein/Aus-Druckschalter
- Ondulierdüse

Halterung für Schublade

- Ein/Aus-Sicherheitsschalter mit Beleuchtung
- Kabel 3 m für Anschluss an das Stromnetz

IT | Asciugacapelli

- Tasto di regolazione:
2 posizioni di flusso d'aria,
3 posizioni di temperatura d'aria
- Posizione COOL per getto d'aria tiepida
- Pulsante acceso/spento
- Bocchetta

Supporto da cassetto

- Interruttore luminoso acceso/spento di sicurezza
- Cavo 3 m per collegamento alla rete di alimentazione

FR | Sèche-cheveux

- Interrupteur à glissière:
2 positions de ventilation,
3 positions de chauffe
- Position COOL à air tiède
- Bouton poussoir on/off
- Concentrateur d'air

Support pour tiroir

- Interrupteur de sécurité on/off avec lampe témoin
- Câble 3 m pour le raccordement au réseau électrique



Energy Saving

Colour: WHITE



Mod. 533.05/033

MOD. 533.03/033

Premium 1200 Drawer 1200W

EN | Same as mod. 533.05/033, but
1200W

IT | Come mod. 533.05/033, ma:
1200W

DE | Wie Mod. 533.05/033, jedoch:
1200W

FR | Comme mod. 533.05/033, mais:
1200W



Eco Friendly

Colour: WHITE



Mod. 533.03/033





Swiss Metal Master
Very stylish,
very professional,
surprisingly lightweight

MOD. 584.03/P

Swiss Metal Master Light Push
1200W

**EN | Hairdryer
with On/Off push button**

- Metal body in chrome plated premium steel
- LONG-LIFE DC-Pro Motor
- 6 air flow/temperature combinations
- Ultra-narrow concentrator nozzle
- Removable metallic filter
- Spiral cable

**DE | Haartrockner
mit Ein/Aus-Druckschalter**

- Metallgehäuse aus verchromtem Premium-Stahl
- DC-Pro LONG-LIFE Motor
- 6 Temperatur/Luftstrom-Schaltkombinationen
- Extra schmale Ondulierdüse
- Abnehmbarer Metallfilter
- Spiralkabel

**IT | Asciugacapelli
con pulsante acceso/spento**

- Corpo in acciaio cromato Premium
- Motore DC-Pro LONG-LIFE
- 6 combinazioni di temperatura/flusso d'aria
- Bocchetta ultrastretta
- Filtro metallico removibile
- Cordone spiralato

**FR | Sèche-cheveux
avec bouton poussoir on/off**

- Corps en acier chromé Premium
- Moteur DC-Pro LONG-LIFE
- 6 combinaisons de température/ventilation
- Embout concentrateur ultra-fin
- Filtre métallique amovible
- Cordon spiralé



Eco Friendly

Colour: CHROME



Mod. 584.03/P

MOD. 533.05

Premium 1600 Push 1600W

EN | Hairdryer with On/Off push button

- Slide switch: 2 air flow settings, 3 air temperature settings
- COOL air setting
- Concentrator nozzle
- Spiral cable

DE | Haartrockner mit Ein/Aus-Druckschalter

- Schiebetaste: 2 Lüfterstufen, 3 Temperaturstufen
- Abkühlstufe COOL
- Ondulierdüse
- Spiralkabel



Energy Saving

IT | Asciugacapelli con pulsante acceso/spento

- Tasto di regolazione: 2 posizioni di flusso d'aria, 3 posizioni di temperatura d'aria
- Posizione COOL per getto d'aria tiepida
- Bocchetta
- Cordone spiralato

FR | Sèche-cheveux avec bouton poussoir on/off

- Interrupteur à glissière: 2 positions de ventilation, 3 positions de chauffe
- Position COOL à air tiède
- Concentrateur d'air
- Cordon spiralé

Colour: WHITE



533.05

MOD. 533.03

Premium 1200 Push 1200W



EN | Same as mod. 533.05, but: 1200W

IT | Come mod. 533.05, ma: 1200W

DE | Wie Mod. 533.05, jedoch: 1200W

FR | Comme mod. 533.05, mais: 1200W

Colour: WHITE



533.03



MOD. 554.02

Executive 1200 Push 1200W

EN | Hairdryer with On/Off push button

- Slide switch: 2 air flow/temperature settings
- Concentrator nozzle
- Spiral cable

DE | Haartrockner mit Ein/Aus-Druckschalter

- Schiebetaste: 2 Temperatur/ Luftstrom-Schaltkombinationen
- Ondulierdüse
- Spiralkabel



Eco Friendly

IT | Asciugacapelli con pulsante acceso/spento

- Tasto di regolazione: 2 combinazioni di temperatura/flusso d'aria
- Bocchetta
- Cordone spiralato

FR | Sèche-cheveux avec bouton poussoir on/off

- Interrupteur à glissière: 2 combinaisons de température/ventilation
- Concentrateur d'air
- Cordon spiralé

Colour: WHITE



554.02





Excel Push
Ultra-lightweight,
comfortable drying



MOD. 561.22

Excel 1875 Push 1875W

EN | Hairdryer with On/Off push button

- 6 air flow/temperature combinations incl. COOL air setting
- Removable filter
- Concentrator nozzle
- Spiral cable

DE | Haartrockner mit Ein/Aus-Druckschalter

- 6 Temperatur/Luftstrom-Schaltkombinationen inkl. Abkühlstufe COOL
- Abnehmbarer Filter
- Ondulierdüse
- Spiralkabel

IT | Asciugacapelli con pulsante acceso/spento

- 6 combinazioni di temperatura/ flusso d'aria compresa la posizione COOL
- Filtro asportabile
- Bocchetta
- Cordone spiralato

FR | Sèche-cheveux avec bouton poussoir on/off

- 6 combinaisons de température/ ventilation compris la position COOL
- Filtre amovible
- Concentrateur d'air
- Cordon spiralé

MOD. 561.17

Excel 1600 Push 1600W

EN | Same as mod. 561.22, but:

1600W

DE | Wie Mod. 561.22, jedoch:

1600W

IT | Come mod. 561.22, ma:

1600W

FR | Comme mod. 561.22, mais:

1600W



Energy Saving

Colour: WHITE



Mod. 561.22

Colour: WHITE



Mod. 561.17

MOD. 542.14

Action 1800 Push 1800W

EN | Hairdryer with On/Off push button

- Slide switch:
2 air flow settings,
3 air temperature settings
- COOL air setting
- Concentrator nozzle
- Spiral cable

DE | Haartrockner mit Ein/Aus-Druckschalter

- Schiebetaste:
2 Lüfterstufen,
3 Temperaturstufen
- Abkühlstufe COOL
- Onduliertdüse
- Spiralkabel



IT | Asciugacapelli con pulsante acceso/spento

- Tasto di regolazione:
2 posizioni di flusso d'aria,
3 posizioni di temperatura
- Posizione COOL per getto d'aria tiepida
- Bocchetta
- Cordone spiralato

FR | Sèche-cheveux avec bouton poussoir on/off

- Interrupteur à glissière:
2 positions de ventilation,
3 positions de chauffe
- Position COOL à air tiède
- Concentrateur d'air
- Cordon spiralé



Colour: WHITE/CHROME		Mod. 542.14 WHITE
Colour: BLACK/CHROME		Mod. 542.14 BLACK
Colour: BLACK		Mod. 542.14 ALL BLACK



MOD. 542.06

Action 1600 Push 1600W

EN | Same as mod. 542.14, but:
1600W



IT | Come mod. 542.14, ma:
1600W

DE | Wie Mod. 542.14, jedoch:
1600W

FR | Comme mod. 542.14, mais:
1600W



Energy Saving

Colour: WHITE/CHROME		Mod. 542.06 WHITE
Colour: BLACK/CHROME		Mod. 542.06 BLACK
Colour: BLACK		Mod. 542.06 ALL BLACK



MOD. 542.05

Action 1200 Push 1200W

EN | Same as mod. 542.14, but:
1200W



IT | Come mod. 542.14, ma:
1200W

DE | Wie Mod. 542.14, jedoch:
1200W

FR | Comme mod. 542.14, mais:
1200W



Eco Friendly

Colour: WHITE/CHROME		Mod. 542.05 WHITE
Colour: BLACK/CHROME		Mod. 542.05 BLACK
Colour: BLACK		Mod. 542.05 ALL BLACK





Fold Away
Space saving,
super lightweight
and professional

MOD. SL 5400 TF

Fold Away 5400 Ionic TF 2000W

EN | Ultra-light hairdryer

- Foldable handle
- Ions generator
- LONG-LIFE DC Motor
- Security thermal cutoff
- 6 air flow/temperature combinations
- Cool air button
- Hinged air inlet grille
- Concentrator nozzle
- SuperFlex cable

DE | Ultraleichter Haartrockner

- Klappgriff
- Ionen-Generator
- LONG-LIFE DC Motor
- Thermosicherung
- 6 Temperatur/Luftstrom-Schaltkombinationen
- Abkühl Taste
- Lufteintrittsgitter mit Scharnier
- Ondulierdüse
- Super-Flex-Kabel

IT | Asciugacapelli ultra leggero

- Manico pieghevole
- Generatore di ioni
- Motore DC LONG-LIFE
- Termofusibile di sicurezza
- 6 combinazioni di temperatura/ flusso d'aria
- Tasto aria tiepida
- Griglia di aspirazione incernierata
- Bocchetta
- Cordone SuperFlex

FR | Sèche-cheveux ultraléger

- Poignée pliante
- Ionisateur
- Moteur DC LONG-LIFE
- Fusible thermique de sécurité
- 6 combinaisons de température/ ventilation
- Bouton à air tiède
- Grille d'entrée d'air montée sur charnière
- Concentrateur d'air
- Câble SuperFlex



Colour: BLACK



Mod. SL 5400 TF

MOD. 561.08/I TF

Excel 2000 Ionic TF 2000W

Hotel Rooms 

EN | Ultra-light hairdryer

- Ions generator
- Security thermal cutoff
- 6 air flow/temperature combinations incl. COOL air setting
- Concentrator nozzle
- Removable filter
- SuperFlex cable

DE | Ultraleichter Haartrockner

- Ionen-Generator
- Thermosicherung
- 6 Temperatur/Luftstrom-Schaltkombinationen inkl. Abkühlstufe COOL
- Ondulierdüse
- Abnehmbarer Filter
- Super-Flex-Kabel

IT | Asciugacapelli ultra leggero

- Generatore di ioni
- Termofusibile di sicurezza
- 6 combinazioni di temperatura/ flusso d'aria compresa la posizione COOL
- Bocchetta
- Filtro asportabile
- Cordone SuperFlex

FR | Sèche-cheveux ultraléger

- Ionisateur
- Fusible thermique de sécurité
- 6 combinaisons de température/ ventilation y compris la position COOL
- Concentrateur d'air
- Filtre amovible
- Câble SuperFlex



Colour: BLACK



Mod. 561.08/I TF



MOD. 561.19 TF

Excel 1800 TF 1800W

EN | Ultra-light hairdryer

- With wall holder mod. 034
- Security thermal cutoff
- 6 air flow/temperature combinations
- Cool air button
- Concentrator nozzle
- Removable filter
- SuperFlex cable

DE | Ultraleichter Haartrockner

- Mit Wandhalter Mod. 034
- Thermosicherung
- 6 Temperatur/Luftstrom-Schaltkombinationen
- Abkühl Taste
- Ondulierdüse
- Abnehmbarer Filter
- Super-Flex-Kabel

IT | Asciugacapelli ultra leggero

- Con supporto a muro mod. 034
- Termofusibile di sicurezza
- 6 combinazioni di temperatura/flusso d'aria
- Tasto aria tiepida
- Bocchetta
- Filtro asportabile
- Cordone SuperFlex

FR | Sèche-cheveux ultraléger

- Avec support mural mod. 034
- Fusible thermique de sécurité
- 6 combinaisons de température/ ventilation
- Bouton à air tiède
- Concentrateur d'air
- Filtre amovible
- Câble SuperFlex



Colours: BLACK



Mod. 561.19 TF



Accessories

MOD. 040

For MOD. SXJ., SL., 542., 561., 584..

Universal

EN | Universal wall holder for hairdryers

IT | Supporto da parete universale per asciugacapelli

DE | Universeller Wandhalter für Haartrockner

FR | Support mural universel pour sèche-cheveux



MOD. 040/C

For MOD. SXJ., SL., 542., 561., 584..

Universal Chrome

EN | Same as Mod. 040, but chrome plated

IT | Come Mod. 040, ma cromato

DE | Wie Mod. 040, jedoch verchromt

FR | Comme Mod. 040, mais chromé



MOD. 034

For MOD. SL., 561., 542., 554., 533..

Jolly

EN | Ring-shaped wall holder with cable locking device for hairdryer

IT | Supporto da parete ad anello con dispositivo blocca cavo per asciugacapelli

DE | Ringförmiger Wandhalter für Haartrockner mit Kabelsperrvorrichtung

FR | Support mural à anneau avec dispositif de blocage du fil pour sèche-cheveux



MOD. 034/C

For MOD. SL., 561., 542., 554., 533..

Jolly Chrome

EN | Same as Mod. 034, but chrome plated

IT | Come Mod. 034, ma cromato

DE | Wie Mod. 040, jedoch verchromt

FR | Comme Mod. 040, mais chromé



MOD. B01

Black Pouch

EN | Protective Bag 300x400 mm

IT | Sacchetto di protezione 300x400 mm

DE | Aufbewahrungsbeutel 300x400 mm

FR | Sachet de protection 300x400 mm



New Valera Individual

The power of personalized branding. Swiss Made for you.



EN | To meet the image needs of the most demanding hotels, we have created Valera Individual, a collection of hairdryers that can be personalized with the hotel logo. Associating the hotel brand with "Made in Switzerland" and Valera's design creates an atmosphere full of personality, increasing customer satisfaction.

DE | Um den Imagebedürfnissen der anspruchsvollsten Hotels entgegenzukommen, gibt es jetzt Valera Individual, eine Kollektion von Haartrocknern, die mit dem Hotel-Logo personalisiert werden können. Die eigene Hotelmarke mit „Made in Switzerland“ und Valera Design in Verbindung zu bringen, schafft eine Atmosphäre, die Individualität betont und die Kundenzufriedenheit erhöht.

IT | Per soddisfare le esigenze di immagine degli alberghi più esigenti abbiamo creato Valera Individual, una collezione di asciugacapelli personalizzabili con il logo dell'hotel. Associare il brand dell'albergo al "Made in Switzerland" e al design di Valera significa creare un'atmosfera ricca di personalità, aumentando il grado di soddisfazione dei clienti.

FR | Pour répondre aux besoins d'image des hôtels les plus exigeants, nous avons créé Valera Individual, une ligne de sèche-cheveux pouvant être personnalisés avec le logo de l'hôtel. L'association de la marque de l'hôtel, du « Made in Switzerland » et du design Valera crée une atmosphère à forte personnalité, qui augmente la satisfaction du client.

For more information: mktg.valera@ligo.com



Automatic Hand Dryer

Handy
Space saving,
eco-friendly
and hygienically
contactless

MOD. 831.01

Handy 1500W

EN | Powerful and compact automatic hand dryer

- Long life AC Heavy Duty motor
- Automatic on/off switching through infrared sensor
- Safety timer
- Easy wall-mounting without opening the appliance
- 2 possibilities of electrical wiring: direct connection to electrical mains (hardwire), connection with plug (softwire)
- Fixation screws and screw anchors incl.

DE | Leistungsstarker und automatischer Kompakt-Händetrockner

- Long-Life Motor AC Heavy Duty
- Automatische Einschaltung durch Infrarot-Näherungsschalter
- Sicherheits-Zeitschalter
- Praktische Wandmontage ohne das Gerät öffnen zu müssen
- 2 Anschlussmöglichkeiten: Elektrischer Festanschluss, Direkter Steckeranschluss
- Einschl. Schrauben und Dübel zur Wandbefestigung

IT | Potente e compatto asciugamani automatico

- Motore a lunga durata AC Heavy Duty
- Accensione automatica tramite sensore a infrarossi
- Timer di sicurezza
- Pratico montaggio a muro senza necessità di aprire l'apparecchio
- 2 possibilità di allacciamento a rete: diretto a cavo di rete che esce dal muro (hardwire), alla presa tramite cavo con spina (softwire)
- Completo di tasselli + viti per il fissaggio a muro

FR | Sèche-mains automatique, puissant et compact

- Moteur longue durée AC Heavy Duty
- Allumage automatique par capteur à infrarouges
- Temporisateur de sécurité
- Montage au mur pratique sans ouverture de l'appareil
- 2 possibilités de raccordement au réseau électrique: direct par un câble d'alimentation relié à un boîtier de raccordement mural, à une prise électrique par câble avec fiche
- Jeu complet de chevilles + vis pour fixation au mur



Automatic



1.000 h
Extra Long
Life



Super Easy
Installation



IP23



Super
Safety

Colour: WHITE



Mod. 831.01



Mirrors

Simple elegance, high-quality finish and robust longevity characterise **the wall mirrors** that complete the Valera Hospitality range.

Schlichte Eleganz, hochwertige Verarbeitung sowie robuste Langlebigkeit charakterisieren **die Wandspiegel**, die das Valera Hospitality Sortiment ergänzen.

Sobria eleganza, finiture di alta qualità e robustezza caratterizzano gli **specchi da parete** che completano la gamma Valera Hospitality.

Une sobre élégance, une finition de qualité et une solidité gage de longévité caractérisent **les miroirs muraux** qui complètent la gamme Valera Hospitality.



MOD. 207.09

Optima Light Smart

EN | Wall-mounted magnifying mirror with automatic LED lighting

- Automatic light activation through proximity sensor
- LED lighting 100-240 V, 50-60 Hz
- 3x magnifying mirror
- Arm length 180 mm
- Full pivotal adjustment
- Material: brass
- Finishing: chrome
- Mirror: Ø 216 mm
- Hard wire application
- Degree of protection: IP 44

DE | Wandmontierter Vergrößerungsspiegel mit automatischer LED-Beleuchtung

- Automatische Lichtaktivierung durch Näherungssensor
- LED-Beleuchtung 100-240 V, 50-60 Hz
- 3-fach-Vergrößerungsspiegel
- Schwenkarm: Länge 180 mm
- Komplett schwenkbar
- Material: Messing
- Oberfläche: Chrom
- Spiegel: Ø 216 mm
- Fest verdrahtet
- Schutzgrad: IP 44

IT | Specchio ingranditore da parete con illuminazione LED automatica

- Attivazione automatica della luce tramite sensore di prossimità
- Lampade LED 100-240 V, 50-60 Hz
- Specchio ingranditore 3x
- Lunghezza braccio 180 mm
- Completamente orientabile
- Materiale: ottone
- Finitura: cromo
- Specchio: Ø 216 mm
- Versione cablata
- Grado di protezione: IP 44

FR | Miroir agrandisseur mural avec éclairage LED automatique

- Activation automatique de la lumière par capteur de proximité
- Éclairage LED 100-240 V, 50-60 Hz
- Miroir agrandisseur 3x
- Bras: longueur 180 mm
- Entièrement orientable
- Matériel: laiton
- Finition: chrome
- Miroir: Ø 216 mm
- Application câblée
- Degré de protection: IP 44



MOD. 207.05

Optima Light One

EN | Wall mounted, LED-lighted magnifying mirror

- LED lighting 100-240 V, 50-60 Hz
- On/Off switch
- 3x magnifying mirror
- Arm length 180 mm
- Full pivotal adjustment
- Material: brass
- Finishing: chrome plated
- Mirror: Ø 216 mm
- Hard wire application
- Degree of protection: IP 44

DE | LED-beleuchteter Vergrößerungsspiegel mit Wandhalterung

- LED-Beleuchtung 100-240 V, 50-60 Hz
- Ein/Aus-Schalter
- 3-fach-Vergrößerungsspiegel
- Schwenkarm: Länge 180 mm
- Komplett schwenkbar
- Material: Messing
- Oberfläche: Chrom
- Spiegel: Ø 216 mm
- Fest verdrahtet
- Schutzgrad: IP 44

IT | Specchio ingranditore a LED da parete

- Lampade LED 100-240 V, 50-60 Hz
- Interruttore On/Off
- Specchio ingranditore 3x
- Lunghezza braccio 180 mm
- Completamente orientabile
- Materiale: ottone
- Finitura: cromo
- Specchio: Ø 216 mm
- Versione cablata
- Grado di protezione: IP 44

FR | Miroir agrandisseur éclairé LED à fixation murale

- Éclairage à LED 100-240 V, 50-60 Hz
- Interrupteur On/Off
- Miroir agrandisseur 3x
- Bras: longueur 180 mm
- Entièrement orientable
- Matériel: laiton
- Finition: chrome
- Miroir: Ø 216 mm
- Application câblée
- Degré de protection: IP 44



MOD. 207.01A

Optima Classic

EN | Wall-mounted double sided magnifying mirror

- Plain mirror + 4x magnifying mirror
- Twin arm: extended length 330 mm
- Full pivotal adjustment
- Material: Steel
- Finishing: chrome
- Mirror: Ø 200 mm

DE | Vergrößerungsspiegel mit Wandhalterung

- Normaler Spiegel + 4-fach-Vergrößerungsspiegel
- Doppelter Gelenkarm: Gesamtlänge 330 mm
- Komplettschwenkbar
- Material: Stahl
- Oberfläche: Chrom
- Spiegel: Ø 200 mm

IT | Specchio ingranditore bifacciale da parete

- Specchio normale + specchio ingranditore 4x
- Braccio doppio: lunghezza braccio esteso 330 mm
- Completamente orientabile
- Materiale: acciaio
- Finitura: cromo
- Specchio: Ø 200 mm

FR | Miroir agrandisseur à fixation murale

- Miroir normal + miroir agrandisseur 4x
- Double bras: longueur 330 mm
- Entièrement orientable
- Matériel: acier
- Finition: chrome
- Miroir: Ø 200 mm



MOD. 207.00

Optima Bar

EN | Wall-mounted double sided magnifying mirror

- Plain mirror + 3x magnifying mirror
- Arm length 220 mm
- Bar length 155 mm
- Full pivotal and in height adjustable
- Material: steel
- Finishing: chrome
- Mirror: Ø 229 mm

DE | Vergrößerungsspiegel mit Wandhalterung

- Normaler Spiegel + 3-fach-Vergrößerungsspiegel
- Schwenkarm: Länge 220 mm
- Wandstange: Länge 155 mm
- Höhenverstellbar und komplett schwenkbar
- Material: Stahl
- Oberfläche: Chrom
- Spiegel: Ø 229 mm

IT | Specchio ingranditore bifacciale da parete

- Specchio normale + specchio ingranditore 3x
- Lunghezza braccio 220 mm
- Lunghezza barra 155 mm
- Regolabile in altezza e completamente orientabile
- Materiale: acciaio
- Finitura: cromo
- Specchio: Ø 229 mm

FR | Miroir agrandisseur à fixation murale

- Miroir normal + miroir agrandisseur 3x
- Bras: longueur 220 mm
- Barre: longueur 155 mm
- Se règle en hauteur et est entièrement orientable
- Matériel: acier
- Finition: chrome
- Miroir: Ø 229 mm



Compare the Features!

	Model	Colour	Watt	Security	Electrostop	Socket	Certification Marks	Energy Saving	Eco Friendly
Hotello BLDC (p.13)	832.11/T 832.11/T MATT-BLACK	○ ●	1500 W				CE N		
Hotello SUPER AC (p.15)	832.02/T 832.02/T MATT-BLACK	○ ●	1400W				CE N		
Hotello SUPER AC Shaver (p.15)	832.02/RT 832.02/RT MATT-BLACK	○ ●	1400W				CE N		
Silent Jet PROTECT 2000 (p.17)	586.10/044.04	○	2000W	4X SECURITY			CE N		
Silent Jet PROTECT 2000 Shaver (p.17)	586.10/044.06	○	2000W	4X SECURITY			CE N		
Swiss METAL MASTER Push (p.18)	584.02/IP	●	2000W	2X SECURITY PUSH			CE N		
Swiss Silent Jet 8500 Push (p.19)	SXJ 8500P	●	2000W	2X SECURITY PUSH			CE N		
Swiss Silent Jet 8500 Ionic TF (p.19)	SXJ 8500 RC TF	●	2000W	2X SECURITY TF			CE N		
Hotello (p.21)	832.01/T 832.01/T SILVER 832.01/T MATT-BLACK	○ ● ●	1200W				CE N		
Hotello Shaver (p.21)	832.01/RT 832.01/RT MATT-BLACK	○ ●	1200W				CE N		
Silent Jet PROTECT 1200 (p.23)	586.11/044.04 WHITE	○	1200W	4X SECURITY			CE N		
Silent Jet PROTECT 1200 Shaver (p.23)	586.11/044.06 WHITE	○	1200W	4X SECURITY			CE N		
Excel PROTECT 1600 (p.25)	561.17/044.04 WHITE	○	1600W	4X SECURITY			CE N		
Excel PROTECT 1600 Shaver (p.25)	561.17/044.06 WHITE	○	1600W	4X SECURITY			CE N		
Excel 1600 Shaver (p.27)	561.17/044.05 WHITE 561.17/044.05 SILVER 561.17/044.05 BLACK	○ ● ●	1600W	3X SECURITY			CE N		
Action PROTECT 1600 (p.28)	542.06/044.04 WHITE 542.06/044.04 BLACK	○ ●	1600W	4X SECURITY			CE N		
Action PROTECT 1600 Shaver (p.29)	542.06/044.06 WHITE 542.06/044.06 BLACK	○ ●	1600W	4X SECURITY			CE N		
Action PROTECT 1600 Socket (p.29)	542.06/044.03 BLACK	●	1600W	4X SECURITY			CE N		
Action Super Plus 1600 Shaver (p.30)	542.06/044.05 WHITE 542.06/044.05 SILVER 542.06/044.05 BLACK	○ ● ●	1600W	3X SECURITY			CE N		
Action Super Plus 1800 (p.31)	542.14/038A WHITE 542.14/038A BLACK 542.14/038A ALL BLACK	○ ● ●	1800W	3X SECURITY			CE N		
Action Super Plus 1600 (p.31)	542.06/038A WHITE 542.06/038A BLACK 542.06/038A ALL BLACK	○ ● ●	1600W	3X SECURITY			CE N		
Action Super Plus 1200 (p.31)	542.05/038A WHITE 542.05/038A BLACK 542.05/038A ALL BLACK	○ ● ●	1200W	3X SECURITY			CE N		
Premium PROTECT 1200 (p.33)	533.03/044.04 WHITE	○	1200W	4X SECURITY			CE N		
Premium PROTECT 1200 Shaver (p.33)	533.03/044.06 WHITE	○	1200W	4X SECURITY			CE N		
Premium Smart 1600 Socket (p.34)	533.05/044.02	○	1600W	3X SECURITY			CE N		

	Model	Colour	Watt	Security	Electrostop	Socket	Certification Marks	Energy Saving	Eco Friendly
Premium Smart 1200 Socket (p.34)	533.03/044.02	○	1200W	3X SECURITY		Socket 1&A	CE N		
Premium Smart 1600 Shaver (p.35)	533.05/044.05	○	1600W	3X SECURITY		Security Shaver Socket	CE N		
Premium Smart 1200 Shaver (p.35)	533.03/044.05	○	1200W	3X SECURITY		Security Shaver Socket	CE N		
Premium 1600 Super (p.36)	533.05/038A	○	1600W	3X SECURITY			CE N		
Premium 1200 Super (p.36)	533.03/038A	○	1200W	3X SECURITY			CE N		
Premium 1600 (p.37)	533.06/038A	○	1600W	3X SECURITY			CE N		
Premium 1200 (p.37)	533.04/038A	○	1200W	3X SECURITY			CE N		
Premium 1100 (p.37)	533.15/038B	○	1100W	2X SECURITY PUSH			CE N		
Executive 1200 Super (p.38)	554.02/038A	○	1200W	3X SECURITY			CE N		
Executive 1200 (p.38)	554.01/038B	○	1200W	2X SECURITY PUSH			CE N		
Premium 1600 Drawer (p.39)	533.05/033	○	1600W	3X SECURITY			CE N		
Premium 1200 Drawer (p.39)	533.03/033	○	1200W	3X SECURITY			CE N		
Swiss METAL MASTER Light Push (p.40)	584.03/P	●	1200W	2X SECURITY PUSH			CE N		
Premium 1600 Push (p.41)	533.05	○	1600W	2X SECURITY PUSH			CE N		
Premium 1200 Push (p.41)	533.03	○	1200W	2X SECURITY PUSH			CE N		
Executive 1200 Push (p.41)	554.02	○	1200W	2X SECURITY PUSH			CE N		
Excel 1875 Push (p.42)	561.22	○	1875W	2X SECURITY PUSH			CE N		
Excel 1600 Push (p.42)	561.17	○	1600W	2X SECURITY PUSH			CE N		
Action 1800 Push (p.43)	542.14 WHITE 542.14 BLACK 542.14 ALL BLACK	○ ● ●	1800W	2X SECURITY PUSH			CE N		
Action 1600 Push (p.43)	542.06 WHITE 542.06 BLACK 542.06 ALL BLACK	○ ● ●	1600W	2X SECURITY PUSH			CE N		
Action 1200 Push (p.43)	542.05 WHITE 542.05 BLACK 542.05 ALL BLACK	○ ● ●	1200W	2X SECURITY PUSH			CE N		
FOLD AWAY 5400 Ionic TF (p.44)	SL 5400 TF	●	2000W	2X SECURITY TF			CE N		
Excel 2000 Ionic TF (p.45)	561.08/I TF	●	2000W	2X SECURITY TF			CE N		
Excel 1800 TF (p.45)	561.19 TF	●	1800W	2X SECURITY TF			CE N		
Handy (p.48)	831.01	○	1500W				CE N		

Dimensions

MOD. 832.11/T
HOTELLO BLDC
 1500W

MOD. 832.02/T
HOTELLO SUPER AC
 1400W

MOD. 832.02/RT
HOTELLO SUPER AC
SHAVER
 1400W

MOD. 832.01/T
HOTELLO
 1200W

MOD. 832.01/RT
HOTELLO SHAVER
 1200W

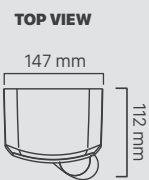
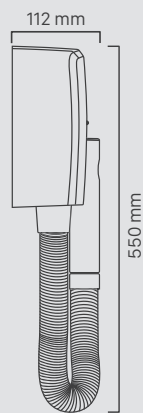
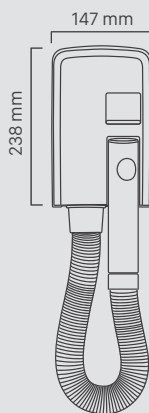

MOD. 561.17/044.05
EXCEL 1600 SHAVER
 1600W

MOD. 561.17/044.06
EXCEL PROTECT 1600
SHAVER
 1600W

MOD. 561.17/044.04
EXCEL PROTECT 1600
 1600W

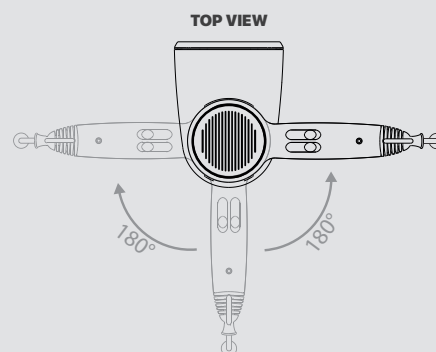
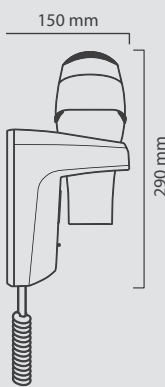
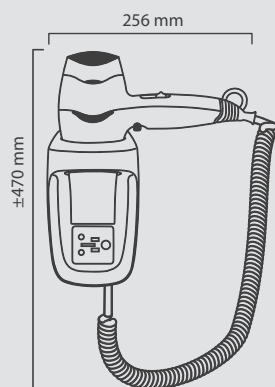

MOD. 542.06/044.05
ACTION SUPER PLUS
1600 SHAVER
 1600W

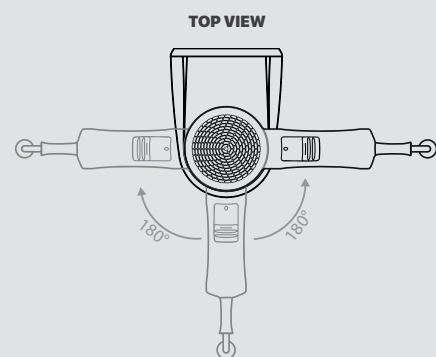
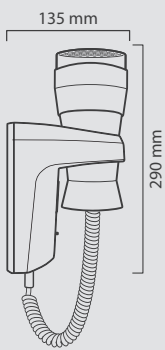
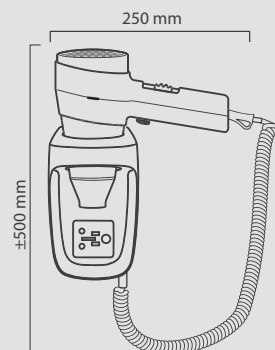

MOD. 542.14/038A
ACTION SUPER PLUS 1800
 1800W

MOD. 542.06/038A
ACTION SUPER PLUS 1600
 1600W

MOD. 542.05/038A
ACTION SUPER PLUS 1200
 1200W

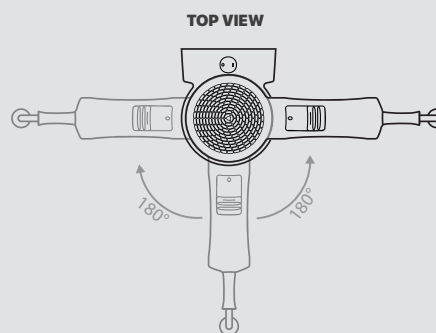
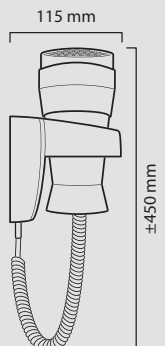
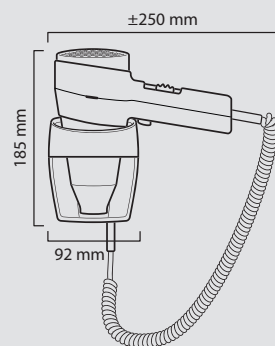

MOD. 554.02/038A
EXECUTIVE 1200 SUPER
1200W

MOD. 554.01/038B
EXECUTIVE 1200
1200W

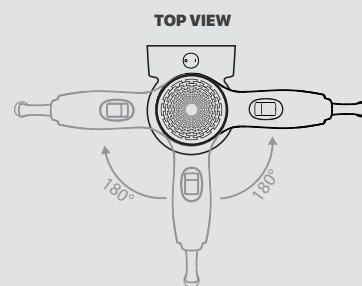
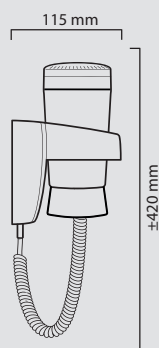
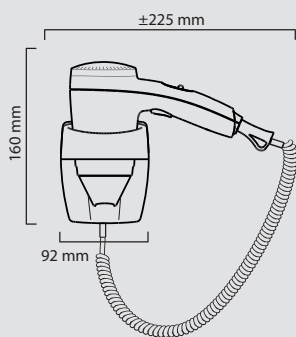

MOD. 542.06/044.06
ACTION PROTECT 1600 SHAVER
1600W

MOD. 542.06/044.03
ACTION PROTECT 1600 SOCKET
1600W

MOD. 542.06/044.04
ACTION PROTECT 1600
1600W

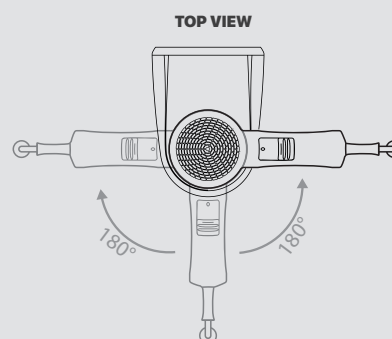
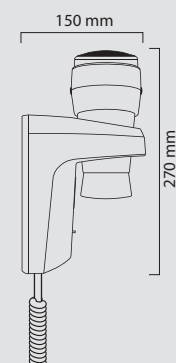
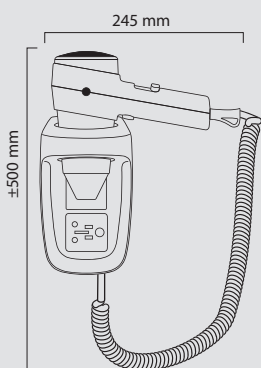

MOD. 533.03/044.06
PREMIUM PROTECT 1200 SHAVER
1200W

MOD. 533.03/044.04
PREMIUM PROTECT 1200
1200W

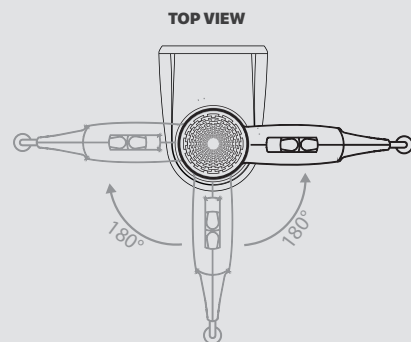
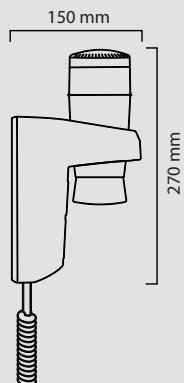
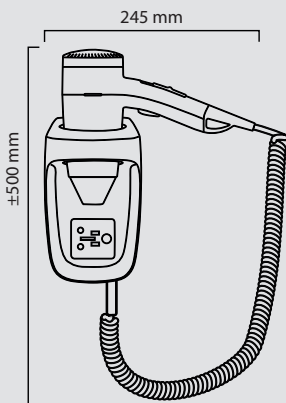

MOD. 533.05/044.02
PREMIUM SMART 1600 SOCKET
1600W

MOD. 533.03/044.02
PREMIUM SMART 1200 SOCKET
1200W

MOD. 533.05/044.05
PREMIUM SMART 1600 SHAVER
1600W

MOD. 533.03/044.05
PREMIUM SMART 1200 SHAVER
1200W

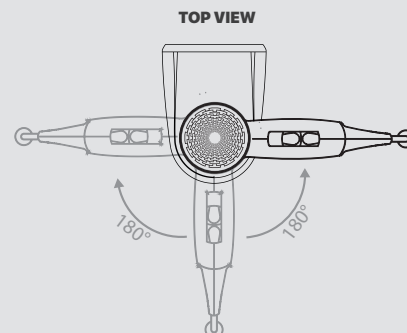
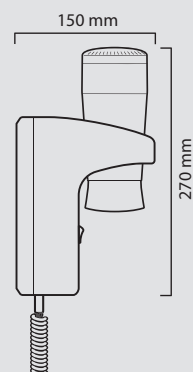
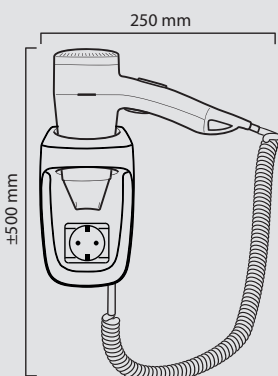

MOD. 533.05/038A
PREMIUM 1600 SUPER
 1600W

MOD. 533.03/038A
PREMIUM 1200 SUPER
 1600W

MOD. 533.06/038A
PREMIUM 1600
 1600W

MOD. 533.04/038A
PREMIUM 1200
 1200W

MOD. 533.15/038B
PREMIUM 1100
 1100W

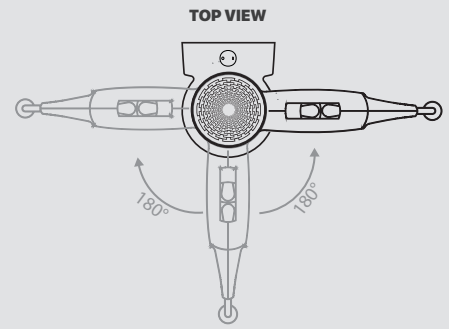
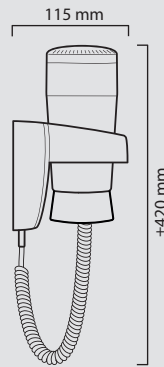
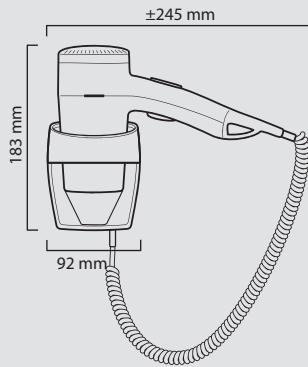

MOD. 586.10/044.06
SILENT JET PROTECT 2000 SHAVER
 2000W

MOD. 586.10/044.04
SILENT JET PROTECT 2000
 2000W

MOD. 586.11/044.06
SILENT JET PROTECT 1200 SHAVER
 1200W

MOD. 586.11/044.04
SILENT JET PROTECT 1200
 1200W

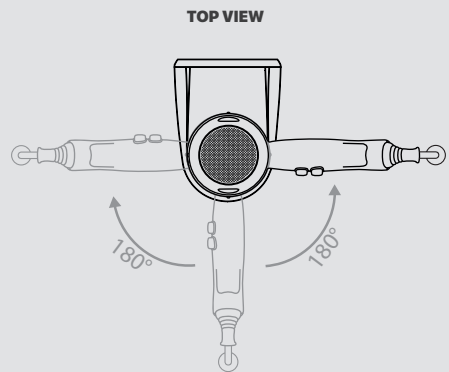
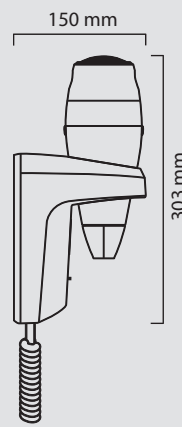
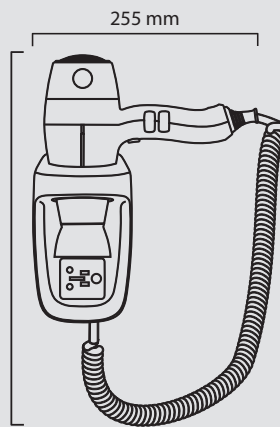

MOD. 584.02/IP
SWISS METAL MASTER PUSH
 2000W

MOD. 584.03/P
SWISS METAL MASTER LIGHT PUSH
 1200W

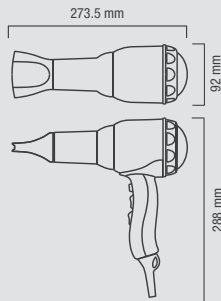

MOD. SXJ 8500 P
SWISS SILENT JET 8500 PUSH
 2000W

MOD. SXJ 8500 RC TF
SWISS SILENT JET 8500 IONIC TF
 2000W

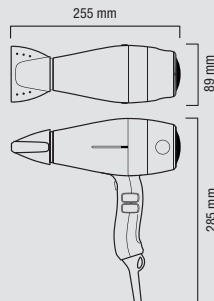

MOD. 561.08/TF
EXCEL 2000 IONIC TF
 2000W

MOD. 561.19 TF
EXCEL 1800 TF
 1800W

MOD. 561.22
EXCEL 1875 PUSH
 1875W

MOD. 561.17
EXCEL 1600 PUSH
 1600W

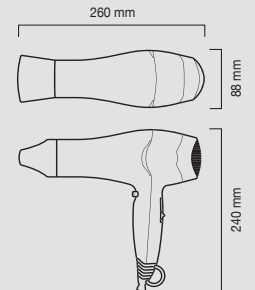

MOD. SL 5400 TF
FOLD AWAY 5400 IONIC TF
 2000W

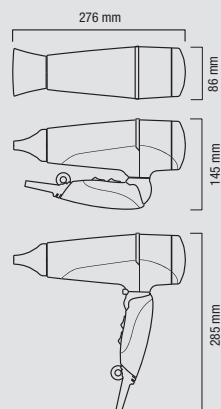

MOD. 554.02
EXECUTIVE 1200 PUSH
 1200W

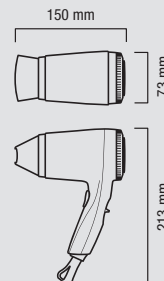

MOD. 533.05
PREMIUM 1600 PUSH
 1600W

MOD. 533.03
PREMIUM 1200 PUSH
 1200W

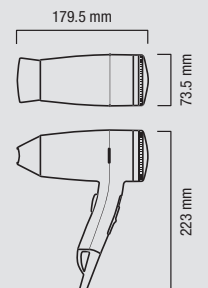

MOD. 542.14
ACTION 1800 PUSH
1800W

MOD. 542.06
ACTION 1600 PUSH
1600W

MOD. 542.05
ACTION 1200 PUSH
1200W

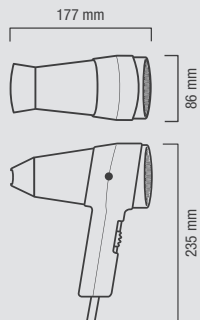

MOD. 831.01
HANDY
1500W

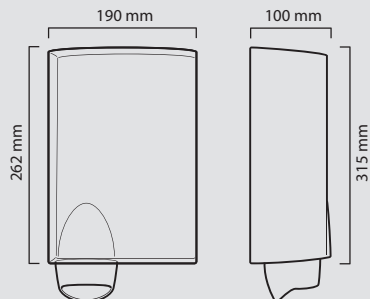

MOD. 533.05/033
**PREMIUM 1600
DRAWER**
1600W

MOD. 533.03/033
**PREMIUM 1200
DRAWER**
1200W

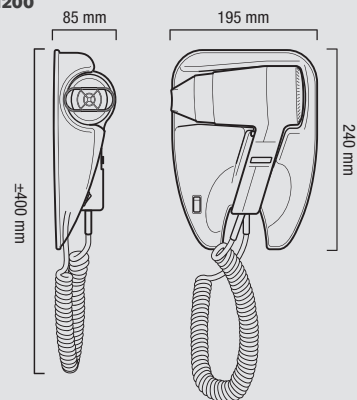

MOD. 207.09
OPTIMA LIGHT SMART

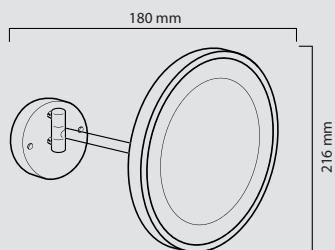

MOD. 207.05
OPTIMA LIGHT ONE

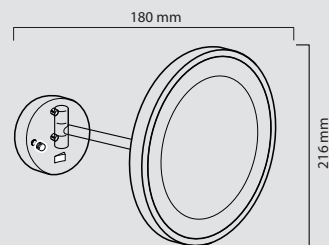

MOD. 207.01A
OPTIMA CLASSIC

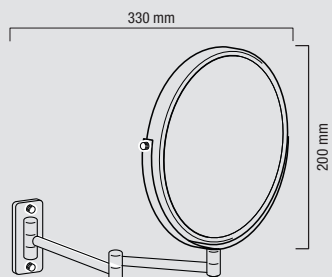

MOD. 207.00
OPTIMA BAR

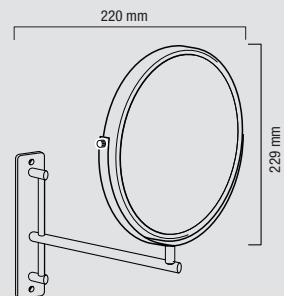

The finest hotels in the world are equipped with Valera hairdryers



Yas Marina Hotel – Abu Dhabi



ANGOLA				
Epic Sana Luanda Hotels	Luanda			
ARMENIA				
Republica Hotel	Yerevan			
AUSTRIA				
Arcotel Gruppe				
Austria Trend Hotels				
Eurothermen Resorts				
Falkensteiner Hotels				
Hotel Sacher	Salzburg			
Hotel Sacher	Vienna			
Schick Hotels	Vienna			
BELGIUM				
Hotel Crown Plaza	Liege			
Hotel Sheraton	Bruxelles			
Hotel Kempinski	Brugge			
BULGARIA				
Flamingo Grand Hotel	Albena			
Kempinski Hotel Grand Arena	Bansko			
Barceló Royal Beach	Sunny Beach			
Duni Royal Resort	Sozopol			
CAPE VERDE				
Hotel Riu Funana	Santa Maria			
CHINA				
Beijing Macao Swissotel	Beijing			
Hilton	Beijing			
Park Hyatt	Beijing			
Peninsula Palace	Beijing			
The Crowne Plaza	Chengdu			
Panda Garden	Chengdu			
Hilton	Dalian			
Kempinski	Dalian			
Radisson Plaza Hotel	Hangzhou			
Park Hyatt	Shanghai			
Renaissance Yangtze Hotel	Shanghai			
Sheraton Hua Ting	Shanghai			
The Portman Ritz-Carlton	Shanghai			
Marco Polo	Shenzen			
The Langham	Shenzen			
ALVA Hotel	Hong Kong			
Grand Hyatt	Hong Kong			
Hyatt Centric Victoria Harbour	Hong Kong			
Hyatt Regency Shatin	Hong Kong			
Hyatt Regency Tsimshatsui	Hong Kong			
JW Marriott	Hong Kong			
Langham Place Hotel	Hong Kong			
Mandarin Oriental Hotel	Hong Kong			
Marco Polo Hong Kong Hotel	Hong Kong			
Mira Moon	Hong Kong			
Regal Hotel	Hong Kong			
Ritz Carlton Hotel	Hong Kong			
Sheraton Hotel	Hong Kong			
The Excelsior	Hong Kong			
The Mira	Hong Kong			
Artyzen Grand Lapa	Macau			
Grand Coloane Resort	Macau			
Grand Hyatt	Macau			
Grand Lisboa	Macau			
St. Regis Hotel	Macau			
CROATIA				
Hotel Excelsior	Dubrovnik			
Hilton Imperial	Dubrovnik			
Sheraton Hotel	Zagreb			
CYPRUS				
Aeneas Resort & Spa	Aya Napa			
Atlantica Miramare Beach	Limassol			
CZECH REPUBLIC				
Hotel Barcelo	Brno			
Grand Hotel Pupp	Karlovy Vary			
Hotel Imperial	Karlovy Vary			
Savoy Westend	Karlovy Vary			
Hotel Ensana Spa	Mariánské Lázně			
Corinthia Hotel	Prague			
Hilton Prague	Prague			
Hotel Paris	Prague			
Hotel President	Prague			
Imperial	Prague			
Intercontinental	Prague			
DENMARK				
Phoenix	Copenhagen			
Tivolo Hotel	Copenhagen			
DOMINICAN REPUBLIC				
Serenade Beach & Spa Resort	Punta Cana			
EGYPT				
Hilton Green Plaza	Alexandria			
Fairmont Heliopolis Cairo	Cairo			
Intercontinental Pyramids Park	Cairo			
Le Meridien Pyramids Hotel	Cairo			
Movenpick Hotel Media City	Cairo			
Ramses Hilton	Cairo			
Sofitel El Gezira Hotel	Cairo			
Steigenberger El Tahrir	Cairo			
The Fairmont Nile City	Cairo			
Pyramisa Hotel & Casino	Giza			
Le Meridien Pyramids Hotel	Giza			
Helnan Dreamland Hotel	Giza			
Hilton Hurghada Plaza	Hurghada			
Le Meridien Luxor Hotel	Luxor			
Maritim Jolie Ville	Luxor			
Cleopatra Luxury Resort	Sharm El Sheikh			
Coral Sea Resort Hotel	Sharm El Sheikh			
Hilton Sharm Waterfalls Resort	Sharm EL Sheikh			
Marriott Beach Resort	Sharm El Sheikh			
Radisson SAS Resort	Sharm El Sheikh			
Savoy	Sharm El Sheikh			
Sheraton	Sharm El Sheikh			
Heights Marriott Beach Resort	Taba			
Hilton	Taba			
Mövenpick	Taba			
ESTONIA				
Baltic Hotel Imperial	Tallin			
Palace	Tallin			
Radisson Hotel Olümpia	Tallin			
FINLAND				
Tallink Silja M/S Silja	Ship			
FRANCE				
Mariott Golden Tulip				
Louvre Hotels Group				
Hotel Gray D'Albion	Cannes			
Disneyland® Hotel	Paris			
Hotel Edouard 7	Paris			
Shangri-La	Paris			
Château de Valmer	La Croix Valmer			
GEORGIA				
Marriott Hotel	Tbilisi			
Kabadoni Boutique Hotel	Sighnaghi			
GERMANY				
Best Western Parkhotel	Erding			
Steigenberger				
Grandhotel and Spa	Heringsdorf (Usedom)			
Hotel an der Oper	München			
Hotel Bayerischer Hof	München			
Vital Hotel Meiser	Neustädtlein			
GREECE				
Four Seasons	Athens			
Astir Palace Hotel	Athens			
Lagonissi Resort	Kerkyra			
Kontokali Bay	Korfu			
Corfu Palace	Kos			
Blue Domes	Kreta			
Amirandes Resort	Kreta			
Robinson Club Kalimera Criti	Kreta			
H-Hotels	Rodos			
Makedonia Palace	Thessaloniki			
HOLLAND				
Jolly Hotel Carlton	Amsterdam			
HUNGARY				
Aquincum Hotel	Budapest			
Budapest Marriott Hotel	Budapest			
Intercontinental	Budapest			
Ramada Plaza Hotel	Budapest			
Spirit Hotel Thermal Spa	Sarvar			
INDIA				
ITC Hotels				
Grand Mercure	Bengaluru			
Ramada Plaza by Wyndham	Chennai			
Caravela Beach Resort	Goa			
The Zuri White Sands	Goa			
Le Meridien	Gurgaon			
Four Point Sheraton	Jaipur			
Taj Umaid Bhawan Palace	Jodhpur			
Swissotel	Kolkata			
JW Marriott, Juhu	Mumbai			
Taj Lands End	Mumbai			
Taj Mahal	Mumbai			
Le Meridien	New Delhi			
Maurya Sheraton Hotel	New Delhi			
Radisson Blu Plaza	New Delhi			
Four Point Sheraton	Pune			
INDONESIA				
Conrad	Bali			
Grand Hyatt	Bali			
Nikko	Bali			
J.W. Marriott	Jakarta			
IRAN				
Dariussh Grand Hotel	Kish Island			
ISRAEL				
The David Citadel Hotel	Jerusalem			
The Crowne Plaza Hotel	Tel Aviv			
ITALY				
MSC Cruises				
IHC Group Italian Hospitality Collection				
Grand Hotel Quisisana	Capri			
Sina Villa Medici	Florence			
Hotel Riz	Forte dei Marmi			
Château Monfort	Milan			
Grand Hotel Vesuvio	Naples			
Hotel Indigo Rome	Rome			
Hotel Rosa Alpina	San Cassiano			
Ruzzini Palace	Venice			
JORDAN				
Bristol Hotel	Amman			
Gand Hyatt Hotel	Amman			
Intercontinental Hotel	Amman			
Kempinski	Amman			
Le Meridien	Amman, Aqaba			
Le Royal Hotel	Amman			
Rotana Hotel	Amman			
Sheraton Hotel	Amman, Dead Sea			
Intercontinental Hotel	Aqaba			
Movenpick Resort Tala Bay	Aqaba			
Radisson SAS Hotel	Aqaba			
Crowne Plaza Hotel & Resort	Dead Sea			
Mövenpick	Dead Sea			
Mövenpick Nabatean	Castle Petra			
KUWAIT				
Safir Airport Hotel	Kuwait City			
Hilton Resort	Mangaf			
LATVIA				
Avalon Hotel	Riga			
LEBANON				
Intercontinental Phoenicia	Beirut			
Lancaster Plaza	Beirut			
Le Royal Hotel & Resort	Beirut			
Marriott Hotel	Beirut			
Metropolitan Hotels & Resorts	Beirut			
Radisson blu	Beirut			
Byblos Sur Mer	Byblos			
Veer Hotel & Resort	Kaslik			
LUXEMBOURG				
Sofitel Le Grand Ducal				
Le Royal Hotels & Resorts				



Baros – Maldives



Sheraton Hotel – Hong Kong



Burj al arab – Dubai



Hotel Kulm – Switzerland

MALAYSIA

LEGOLAND Hotel	Johor Bahru
Hyatt Regency Kinabalu	Kota Kinabalu, Sabah
Grand Hyatt	Kuala Lumpur
Parkroyal Hotel	Kuala Lumpur
The St Regis Resort	Langkawi
Avani Gold Coast Resort	Selangor

MALDIVES

Baros Maldives	
Constance Hotel Experience	

MAURITIUS

Hotel Intercontinental Mauritius Resort	
Shanti Maurice A Nira Resort	

MONACO

Hôtel de Paris	Monte-Carlo
----------------	-------------

MONTENEGRO

Hunguest Hotel Sun Resort	Herceg Novi
---------------------------	-------------

MOROCCO

Hotel Mamounia	Marrakech
----------------	-----------

NORWAY

Norwegian Cruise Line	
Thon Hotels	
Bristol Hotel	Oslo
Radisson Blu Park Hotel	Oslo

OMAN

Intercontinental	Muscat
Shangri-La's Barr	
Al Jissah Resort	Muscat

PHILIPPINES

Boracay Shangri-La Hotel	Boracay Island
The Manila Peninsula Hotel	Makaty City

POLAND

Gdansk Hotel Gdansk	
Copernicus	Krakow
Hotel Saski,	
Curio Collection by Hilton	Krakow
Niebieski Hotel	Krakow
Aquarius	Kolobrzeg
Belweder	Ustron
Hotel Bristol	Warsaw
Intercontinental	Warsaw
The Bridge	Wroclaw

PORTUGAL

Pine Cliffs Resort Algarve	Albufeira
Conrad Algarve Hilton Honors	Almancil
Praia D'El Rey Marriott	
Golf & Beach Resort	Amoreira
Reid's Palace	
A BELMOND Hotel	Funchal
Intercontinental Lisbon IHG	Lisboa
Ritz Four Seasons Hotel	Lisboa
Vila Vita Parc Resort & Spa	Porches

QATAR

Oryx Rotana Hotel	Doha
W Hotel	Doha

ROMANIA

Lotus Therm Spa & Luxury Resort	Baile Felix
Hotel Monte-Nelly	Bucharest
Lebada Luxury Resort & Spa	Crisan

RUSSIA

Crown Plaza	Moscow
Golden Ring	Moscow
Radisson Collection Hotel	Moscow
Izmaylovo	Moscow
President Hotel	Moscow
Moika 22 Kempinski	St.Petersburg
Radisson Resort	Zavidovo

SAUDI ARABIA

Edition Jeddah	Jeddah
Hotel Galleria by Elaf	Jeddah
Grand Hyatt	Khobar
Al-Ghufran Safwah	Makkah

Anjum Hotel	Makkah
Marriott Jabal Omar	Makkah
Mövenpick Hajar Tower	Makkah
Raffles Clock Tower	Makkah
Ramada Hotel & Suites	Qassim

SERBIA

Majdan Lux	Beograd
Ambasador	Niš

SEYCHELLES

Constance Lemuria Resort	Praslin Island
--------------------------	----------------

SINGAPORE

Capella	
Fairmont	
Four Seasons Hotel	
Intercontinental	
Mandarin Orchard	
Mandarin Oriental	
Marina Bay Sands	
Marina Mandarin	
Orchard Hotel	
Raffles	
Rasa Sentosa Resort	
Shangri-la Hotel	
St. Regis	
Swissotel Merchant Court	
Swissotel Stamford	
The Fullerton Hotel	
The Pan Pacific	

SLOVAKIA

SHERATON Bratislava Hotel	Bratislava
Tulip House Hotel	Bratislava
Grand Hotel Permon	Podbanské, Vysoké Tatry

SLOVENIA

Sava Hotels & Resorts	
-----------------------	--

SOUTH AFRICA

Radisson	Cape Town
Hyatt Regency	Johannesburg

SPAIN

Paradores de España	
Hotel Barcelo	
Premium Asia Garden	Alicante
Hotel Boutique Villa Venecia	Alicante
Insotel Fenicia	
Bless Hotel	Ibiza
Prestige Thalasso Spa	Ibiza
Hotel Princesa Yaiza	Lanzarote
Hyatt Regency Hesperia	Madrid
Eco Resort Aqa San Blas	Tenerife
Hard Rock Hotel	Tenerife
Iberostar Anthelia Hotel	Tenerife
Hotel Hilton Buenavista	Toledo

SWEDEN

Elite Plaza Hotel	Gothenburg
Radisson Blue Royal Viking	Stockholm

SWITZERLAND

Arosa Kulm Hotel	Arosa
Grand Hotel Tschuggen	Arosa
Castello del Sole	Ascona
Eden Roc	Ascona
Hotel Giardino	Ascona
Bellevue Palace	Bern
Seehof	Davos
Waldhaus Flims	
Mountain Resort & Spa	Flims
Hotel Anglettere	Genève
Hotel Le Mirador Kempinski	Genève
Intercontinental Hotel	Genève
Mandarin Oriental	Genève
President Wilson Hotel	Genève
Grand Hotel Park	Gstaad
Grandhotel Bellevue	Gstaad
Palace Hotel	Gstaad
Grand Hôtel Les Endroit	La Chaux-de-Fonds
Villa Castagnola	Lugano

Chateau Gütsch	Luzern
Schweizerhof	Luzern
The Hotel	Luzern
Le Mirador Kempinski	Mont-Pèlerin
Fairmont Le Palace	Montreux
Kronenhof	Pontresina
Badrutt's Palace	St.Moritz
Hotel Kulm	St.Moritz
W Hotel	Verbier
Grand Hotel du Lac	Vevey
The Omnia	Zermatt
Atlantis by Giardino	Zürich
Hotel Baur au Lac	Zürich
Hyatt	Zürich

TAIWAN

Hotel Royal	Taipei
Nikko Hotel International	Taipei

THAILAND

The Erawan Group	
Oriental Residence Hotel	Bangkok
Pathumwan Princess Hotel	Bangkok
Pullman King Power	Bangkok
JW Marriott Resort & Spa	Khao Lak
Soneva Kiri Resort	
& Residences	Ko Kut
Saii Laguna	Phuket

TURKEY

Crowne Plaza Group	
Cornelia Diamond Group	
Hilton Group	
Ramada Group	
Swissotel Group	
Sheraton Group	
JW Marriott Hotel	Ankara
Belek Beach Resort	Antalya
Ritz Carlton	Istanbul
Soho House	Istanbul
Bodrum Kempinsky Hotel	Mugla

UAE

Kempinski Group	
Khalidiya Palace	
Rayhaan by Rotana	Abu Dhabi
Rosewood Hotel	Abu Dhabi
Shangri-La	Abu Dhabi
Shangri-La Qaryat Al Beri	Abu Dhabi
Yas Viceroy	Abu Dhabi
Ajman Hotel	Ajman
Al Bandar Rotana	Dubai
Atlantis The Palm	Dubai
Burj al Arab	Dubai
InterContinental Dubai Marina	Dubai
The Meydan Hotel	Dubai
The Palace Downtown	Dubai
Raffles	Dubai
Miramar Al Aqah Beach Resort	Fujairah
The Ritz-Carlton	Ras al Khaima

UKRAINE

Grand Hotel Ukraine	Dnepropetrovsk
Opera Hotel	Kiev
Premier Palace	Kiev
Nobilis Hotel	Lviv
NEMO Hotel Resort & SPA	Odessa
Mirotel Resort & Spa	Truskavets
Rixos Prykarpattya	Truskavets

UNITED KINGDOM

Premier Inn Hotels	
Summerlodge Hotel	Dorchester
Queens Hotel	Leeds
Hilton Stansted	London
Marriott Park Lane	London
Park Plaza Westminster Bridge	London
Celtic Manor Hotel	Newport

YEMEN

Hotel Mövenpick	Sana'a
-----------------	--------

Valera[®]
HOSPITALITY



LIGO ELECTRIC S.A.

Via Ponte Lavaggio, 9 / CH 6853 Ligornetto, Mendrisio / Switzerland
Tel. +41 91 6416620 / Fax +41 91 6473055 / info@ligo.com

WWW.VALERA.COM